

# **THE CLERK OF THE COURSE**

## **GUIDE TO CLERKING**



**By LEONELLO G. COSTANZO**

Updated for 2007 by George Kleeman

**2007**

**PRICE \$3.00**

Part of the USATF National Officials and Pacific Association Monograph Series on how to officiate. Each monograph covers the various techniques for each officiating assignment. These monographs are intended for more in depth understanding of each job. They are intended for both the novice and seasoned official. They cover the real details of the job and how it should be performed. They summarize various techniques to accomplish the job. These monographs can be copied and used for officials training only.

# INDEX

	Page
Introduction	i
Personnel	1
Location of Clerk's Station and Facility Requirements	1
Major Equipment Requirements	1
Additional Equipment Requirements	2
Required Supplies	2
Information Manual	3
Check-in, Staging and Escorting Athletes to Event	3
Check-In Table	3
Staging Area and Procedures	3
Escorting Procedures	4
Assignment of Clerks	4
Announcing	4
Check-in	4
Staging	5
Escorting	5
Line Clerking/Starter's Assistant	5
Reporting Times and Rotation of Assignments	5
Reporting Times	6
Assignment Rotation	6
General Clerking Station Preparations	6
Concluding Comments	7
Appendix	8

# CLERK OF THE COURSE

## **INTRODUCTION**

The heart of all track and field meets is the Clerk Of the Course Station. Excluding delays caused by weather conditions, malfunctions of the automatic timing equipment, false starts, etc., the Clerks have the primary responsibility for maintaining the meet schedule, which has been established by the Games Committee. With this point in mind it is important to note that the efficient operation of a Clerk's Station is directly related to the abilities of and number of assigned personnel, the size of the station and its location, and availability of required equipment and supplies. The following information is presented to serve as a guide for determining how to setup a Clerk's Station, personnel required, and equipment and materials needed to operate the Clerk's Station. The recommendations and procedures outlined below have, in practice, proven to be most effective for operating a Clerk's Station. For major meets such as the Olympic Trials, USATF Championships (Senior and Junior), Junior Olympics, National Youth Athletics and Masters Championships these requirements and procedures are not only necessary but also a must for the successful operation of a Clerk's Station.

## **PERSONNEL**

The Clerk's Station must be adequately staffed and the Chief Clerk and the Assistant Clerks must possess a working knowledge of the applicable rules of competition (i.e. uniform requirements, shoe and spike requirements, qualifying requirements, etc.), must be personable, and willing to be part of the team. Each staff member must be capable and willing to assume each of the individual duties associated with Clerking. Such duties include the following; announcing (calling athletes to report for check-in and to report for staging), checking-in athletes for the individual events, staging athletes (preparation of athletes to be escorted to the event), giving instructions related to the competition, escorting athletes to the field event or starting line, etc. The number of Clerks required is dependent on the following factors:

1. Number of days the meet will be conducted.
2. Number of athletes participating in the meet.
3. Will the clerks or the heads of field events check-in field athletes?
4. Number of heats or flights to be conducted in the preliminaries.
5. Time allotted between events.
6. Is the meet televised (maintaining the time schedule becomes more imperative when a meet is televised)?
7. Location and distance of the Clerk's Station respective to the warm-up area/s and entrance/s to field and track events.

For major meets this could be between 8 to 12 clerks. The minimum number is two, one to man the station and one to escort athletes. In most meets, clerks are involved primarily with track athletes since check-in for field events is delegated to the field event officials.

## **LOCATION OF CLERK'S STATION AND FACILITY REQUIREMENTS**

The Clerks Station, if possible, should be located in close proximity to the warm-up area and medical/trainer's station, rest room facilities and adjacent to the track and field events competition area. The station should be tented and the tent should be large enough to accommodate the required number of check-in tables. If the tent is to also serve as the athlete's staging area (area where the athletes report prior to being escorted to the event) it should be large enough to accommodate the largest number of athletes to be escorted to the event. (See Chart A for sample design of a Clerk's Station)

### **1. Major Equipment Requirements**

- a. Signage - Signs such as Clerk Of the Course, Track Event Check-In, Field Event Check-In, Protest Table, and other similar informational signs are essential. Informational signs enable the athlete to locate the Clerk's Station and proper check-in table/line.
- b. Sufficient lighting to provide adequate lighting for the tent if the meet will extend into the evening hours.
- c. A Public Address system, preferably one connected to speakers located in the warm-up area/s and other areas where athletes may be located (i.e. medical/trainer's tent area).
- d. A clock, large enough so that it can be readily seen by the athlete's (large digital clocks serve effectively for this purpose).

- e. A phone/fax system connected with the Announcer's Booth, Finish Line, Seeding Coordinator, and when applicable TV personnel. Applicable phone and fax numbers should be available if a phone and fax system is provided. If a computer network is available, a station should be available in the clerk's station.
- f. A Posting Board for posting Start Lists and Results of the day's completed events.
- g. Sufficient number of tables and chairs to accommodate the Clerks.
- h. Sufficient number of chairs and/or benches to accommodate the athletes.

## **2. Additional Equipment Requirements**

- a. A Walkie-talkie to enable the Clerks to communicate, when necessary, with field event personnel, Referees, Meet Director, etc.
- b. A hand held audio-hailer or local public address system which can be used to give instructions to large groups of athletes in close in situations.
- c. Spike gauge, essential if Meet Management has specified the size of spikes it will permit to be used on the track or runways for all events or specific events.
- d. A spike wrench and a sufficient supply of the recommended spikes. If spikes are not provided, information should be provided respective to their availability.

## **3. Required Supplies**

- a. Start Lists, a sufficient number of copies should be available to distribute to Check-in Clerk/s, Staging Clerk/s, Finish Line Coordinator or Chief Finish Judge, Chief Timer, Announcer, TV personnel if applicable, and other assigned Clerk/s. Start Lists for check-ins should include composite and individual heat and flight forms.
- b. Meet schedules and daily time schedules. The daily time schedules should include a time line for the following time factors (see sample Chart B)
  - 1. Check-in Time.
  - 2. Report Time (staging time when equipment, uniforms, and spikes are checked, and final competition instructions are given).
  - 3. Escort Time (time when athletes are moved out to the event)
  - 4. Start Time for the event.
- c. Blank competition numbers (to replace damaged or lost numbers).
- d. Stadium plot plan, including locations of; Start and Finish Lines, Field Events, Medical and Trainer's area and Track and Field Events Warm-up areas.
- e. Hip numbers and hip number rack. The numbers should include the highest number needed for any single event.
- f. Athlete's Information Manual. This is essential in order for the Clerks to be able to know what instructions the athletes have received respective to checking times, number to qualify from heats or flights, etc.
- g. Clip boards
- h. Pencils/pens
- i. Large marking pens
- j. Paper clips
- k. Stapler and staples
- l. High lighters
- m. Plain copy paper
- n. If possible, a copy machine.
- o. Whistle.
- p. Scotch and adhesive tape.
- q. Safety Pins.
- r. Batons.
- s. Balls or cards for drawing lanes by lot.
- t. Guide cards of instructions on:
  - Track Markings and event details like:
    - Two Turn Stagger
    - Three Turn Stagger
    - 4x100 Relay Zone and Fly Zone
    - 4x400 Relay Zone
    - Uniform Requirements

## **4. Information Manual**

Though the Clerking Station is not usually designated as an Information Center, it becomes one by default. The reason for this is that it is the one area where every competing athlete must report to check-in and receive final competition instructions. Often athletes report to the Clerk's Station prior to picking up their competition packets. Though the Official's or Athlete's Manual may include most of the pertinent competition information athletes need, Clerk's often are asked to provide information to the following questions:

Location of packet pickup.

Location of medical and trainer's tents.

Location of Inspector of Implements.

Procedure for replacing lost competition numbers.

Procedure for submitting protests.

Location of rest rooms.

Availability of programs and Start Lists for coaches and athletes.

System for awarding awards (by ceremony or from an awards distribution tent).

Length of warm-up period in the field events if the preliminaries are conducted in flights and is it necessary to participate in the general warm-up if flights are to be conducted.

The following information, though mostly applicable to the Clerks, would be helpful if it were also included in the manual.

Meet Management's spike restriction if it is contrary to the competition rulebook restrictions. Information respective to availability of spikes should also be included.

System for adding a declared athlete to the Start List if the athlete's name is missing from the Start List.

The time line when a non-reporting athlete is declared an official scratch from the event.

System for communicating with the Announcer, Finish Line Coordinator or Chief Finish Judge, Chief Timer, Referees, Field Event Judges, Seeding Coordinator, and Meet Director.

Note: Though it is recommended that the above information is made available to the Clerk's, it is not to preclude that the Clerk's Station should be designated as the information center. A separate area should be designated as the Athlete's Information Center for the purpose of providing meet information and to answer the specific questions such as those listed above.

## **CHECKING IN, STAGING AND ESCORTING ATHLETES TO THE EVENT**

Many different systems have been utilized for checking-in, staging, and escorting the athletes to an event. When different procedures for these different elements of clerking are utilized from meet to meet it creates an atmosphere of confusion for the athletes as well as for the assigned Clerks. It would be most beneficial for athletes to know that the same clerking procedures are in effect at every meet that they enter. Though standardization may not always be desired, it cannot be ignored in clerking. The elimination of confusing clerking procedures which is now encountered by athletes will enhance immensely their ability to mentally concentrate on the competition at hand rather than whether or not they have properly followed check-in procedures. Listed below are recommendations for including clerking procedures, which in practice have proven to be most successful. If these procedures became the norm they could help reduce much of the existing confusion associated with checking-in, staging, and escorting athletes to the event/s.

1. **Check-in Table** - The ideal setup is to locate the Track and Field Event Check-ins table/s at the same location. This setup will require less Clerks to man the station since, when necessary, the Check-in Clerks can assist each other when track event and field event athletes are checking-in at the same time. The tables should be setup as follows:

a. Setup two separate tables for track and field event check-ins. The tables should be setup adjacent to each other. For smaller meets the track and field events check-ins, if only one table is available, are setup at opposite ends of the table. b. Depending on time constraints (time allowance between events and number of Clerks assigned, separate lines for men and women and for individual heats and flights can be setup to speed up the checking-in process.

2. **Staging Area and Procedures** - Whenever possible athletes should report to a separate area which is either adjacent to or in close proximity to the check-in table. The area should be tented if possible; this is essential in hot and humid weather conditions. The area should be furnished with enough chairs or benches to accommodate the largest number of athletes reporting for any single event. During staging the following procedures should be followed:

Call out names and line up athletes by heats and lanes for track events and by flights for field events as listed on the Start Lists.

b. Check that competition numbers are correct and worn properly.

c. Re-check uniforms, shoes, and spikes, athletes sometimes change shoes and spikes after they have been initially checked.  
Issue hip numbers and instruct athletes respective to how and when the numbers should be affixed to the uniform. Weather conditions will be a guide for when the numbers should be affixed to the uniform.  
Check for uniform violations and/or logo violations, if necessary.  
Turn over athletes and Start List/s to Escort Clerks.  
Escort athletes to their event if Escort Clerks have not been assigned for this purpose.

3. **Escort Procedures** - Athletes should be escorted to the event via the shortest route possible or via the route as had been determined by the Meet Director or Chief Clerk. When a large number of or more than one heat or flight of athletes is to be escorted, two Clerks should be assigned to escort the athletes, one to lead and one to follow. The Escort Clerk/s should:

Inform athletes to take all of their gear and personal items out to the event with them. This is especially important when basket crews are assigned to transport the athlete's gear to a specific pickup area, if drug testing is being conducted, if a media zone has been established for interviews, etc. If there needs to be a retain area for confiscated equipment or gear, inform the athletes where and when they can pick up such materials after their event.

For field events turn over athletes and Start List/s to the Chief Judge of the field. For track events turn over athletes to the Line Clerk/Starter's Assistant, if one has been assigned. If no one has been assigned to either of these positions turn the Start List over to the Finish Coordinator or Chief Finish Judge.

**Note 1:** At most major meets it is not necessary to turn over the Start Lists to the officials listed above because they usually have their own list. However, as a result of check-in changes it may be necessary to inform them of changes.

**Note 2:** When no Line Clerk/Starter's Assistant or Finish Coordinator has been assigned, the Escort Clerk assumes the responsibility of placing the athletes in their proper lane or position in the case of races which start with a Water Fall start.

c. In the absence of a Line Clerk/Assistant Starter or Finish Coordinator the Escort Clerk waits until the race has officially started before returning to the Clerking Station. In the case of a false start, the Clerk ensures that the athletes are starting in their proper lanes or position and waits for the race to officially start before returning to the Clerk's Station.

## **ASSIGNMENT OF CLERKS**

The Luxury of assigning Clerks to individual clerking responsibilities is primarily dependent on the number of Clerks assigned to assist the Chief Clerk. The Chief Clerk is usually responsible for making the Clerks assignments unless the Meet Director has preset them. If a sufficient number of Clerks have been assigned to man the Clerk's Station, the Clerk's should be assigned to individual responsibilities on a rotating basis. When it is not feasible to do so, assignments should be combined. The ideal setup is to assign Clerks to the following individual responsibilities:

1. **Announcing** - Assigned Clerk has the responsibility for making announcements respective to check-in times and report times as listed on the schedule. Whenever possible 1st, 2nd, and 3rd calls should be made for announcing check-in times.

2. **Checking-in** - Assigned Clerk checks-in the athletes and uses the marking system which had been agreed upon by the Clerking crew to denote that the athlete has checked-in for the event. At check-in time the Clerk checks to ensure that the athlete is wearing the correct competition number as listed on the Start List and that it is being worn properly as per the rules, that the spikes do not exceed the rule book specifications or Meet Management's restrictions, and that the athlete is properly uniformed. In addition to the items which need to be checked the Clerk provides the athlete with the following information:

Heat and lane or position number.

Flight number and warm-up rules.

Number of qualifiers to the next round.

Report time (time that athletes report to staging area in preparation to be escorted to the event).

Note: When an athlete or coach reports that an athlete has to scratch from an event inquire as to the reason for the scratch and make note of this on the Start List. When scratches are reported, the information is passed on to the Staging Clerk, Meet Announcer, Finish Line Coordinator or Chief Finish Judge, and when applicable to the TV personnel. When scratches create a non-competitive situation (the number of entries in any heat or flight are equal to or less than the

number to qualify to the next round) or if the number of athletes is less than the number who will move to the final, it is imperative that the information is relayed to the Seeding Coordinator so that the event can be reseeded or rescheduled.

3. **Staging** - Assigned Clerk is responsible for checking the number of reporting athletes versus the number of official entries on the Start List (minus scratches and no-shows) and for re-checking uniforms, competition numbers, shoes and spikes. If heats and flights are scheduled the Clerk lines up the athletes by heats and flights before turning them and the Start Lists over to the Escort Clerk/s. During Staging, final competition instructions are given and hip numbers are issued. The instructions should include number of athletes to advance, How they advance (i.e. number by place and number by time), number of athletes in the competition, type of start or staggers, what to do with clothing, any special meet instructions or information and reporting times for next round. When adverse conditions such as rain or high humidity exist the hip numbers should not be issued until just prior to the event start time. It may be necessary to have hip numbers pinned to the uniform in such circumstances.

Note: Staging Clerks should have a set of spare hip numbers available to replace non-sticking or lost number/s.

4. **Escorting** - Assigned Clerk should follow the shortest route possible to get athletes to the event or the route, which had been established by the Meet Director or Chief Clerk. When a Line Clerk/Starter's Assistant has been assigned the Escort Clerk turns over the athletes and Start List to the Line Clerk. If a Finish Coordinator has been assigned instead of a Line Clerk/Assistant Starter the Escort Clerk will place the athletes in the proper lane or position before handing the Start List to the Finish Coordinator. In relay races the Line Clerk/Assistant Starter should distribute and collect the batons, if needed.

**Note 1:** Line Clerk is a term used in the United States and Assistant Starter is one used in international competitions conducted under IAAF rules. The responsibilities assumed by each are similar.

**Note 2:** Escort Clerks should have a set of spare hip numbers available to replace non-sticking or lost number/s.

**Note 3:** At many major meets Field Event athletes are generally escorted to the event by the event Flight Coordinator or another official designated by the Chief of the event. This practice should be the standard procedure at all meets since it assures the Clerks that the event officials are in place ready to conduct the competition. An alternative to this procedure is that Chief Event Judge informs the Clerking Station by radio when it is time to escort the athletes to the event.

5. **Line Clerking/Starter's Assistant** - The responsibility of this assigned official is to place the athletes in the proper lanes or positions as listed on the Start List and when a false start occurs to recheck that the athletes have assumed their original assigned lanes or positions.

Note: Line Clerks/Starter's Assistants should have a set of spare hip numbers available to replace nonsticking or lost number/s.

As stated previously, assigning Clerks to individual clerking responsibilities can only be affected if a sufficient number of Clerks are assigned to the Clerk's Station. Unless a sufficient number of officials are assigned it may be necessary to assign more than one responsibility to each Clerk and in a worst case scenario one Clerk can be assigned to announce and check-in and another to stage, escort, and place the athletes in lanes or position. It is for this reason Clerks must be flexible and ready to make adjustments when necessary. When a worst case scenario exists and the Escort Clerk is responsible for escorting more than one heat it is advisable that the Chief Clerk is assigned a Runner who will be responsible for taking the Start Lists to the Finish Line Coordinator and/or Chief Finish Judge. This is especially important when heats are being conducted in the 100m, 100m and 110m hurdles, 200m, 1500m, 3000m, 5000m, and 3000m Steeple Chase.

## **REPORTING TIMES AND ROTATION OF ASSIGNMENTS**

The Chief Clerk, unless the Meet Director has pre-established reporting times and an assignment rotation schedule, is primarily responsible for setting the Clerk's Report Times and Assignment Rotation Schedule. Report times and assignment rotation schedules should be planned so that so that each Clerk has an opportunity to experience each assignment associated with clerking and that each Clerk has a rotation period free of responsibility. If possible, report times should be distributed to the clerks prior to the start of the meet. This will enable the Chief Clerk to make adjustments when necessary, especially when clerks have been assigned to other events.

Clerks need to know location of all race starts. This may require prior review. The chief clerk should walk the track and determine where all the marks before the day of the meet if he or she is not familiar with the track. Although there are standard colors for marks - see below- but they are often not followed. It is best to get with the coach and have him show you the markings if you have never been at this facility. Better yet put them down on paper and have them typed up so you can easily distribute them to the starter, your assistant clerks, and the umpires.

1. **Reporting Times** - Reporting times for check-in are usually determined by the start time for the first event of the day. The general rule of thumb is that the Clerks should be available a minimum of 1/2 hour prior to the first event check-in time. The Report Time for staging and escorting differs and is determined by the number of athletes entered and the number of heats and flights to be staged and escorted. Staging and escort times can be adjusted depending on the number of athletes entered in the event, however, at most major meets the following times usually have been used as pre-event lead times:

	<b>Staging</b>	<b>Escort</b>
a. Track Events -	1/2 hour	15 min.
b. Horizontal Jumps -	1 hour	50 min.
c. Throwing Events -	1 hour	50 min.
d. High Jump -	1 hour	50 min
e. Pole Vault -	1 1/2 hour	70 min.

Note: The above times can be modified when necessary as determined by the following conditions:

- An insufficient number of Clerks have been assigned to operate the Clerk's Station.
- Clerking Station is not located close to the stadium proper.
- Large number of athletes entered in the field events.
- Large number of athletes to be escorted to an event.
- More than one heat or flight is to be escorted at the same time.

2. **Assignment Rotation** - As previously recommended each Clerk should have an opportunity to be responsible for each clerking assignment and be assigned one rotation, which does not involve any responsibility. This holds true especially when meets extend over many days. A rotation, which does not lock a Clerk into any single responsibility for long periods of time, is the most desirable rotation. The number of rotations scheduled is basically determined by the number of events scheduled each day and the length of the meet day. Whenever possible schedules should be prepared and made available to the Clerks prior to the meet and adjustments made when necessary. An assignment schedule should include a rotation order and number key for each assigned Clerk. (See sample Chart C)

## **GENERAL CLERKING STATION PREPARATIONS**

Before a Clerking Station is ready for operation there are basic preparations which require the Clerks attention. Though the overall responsibility for the choice of location and physical setup of the Clerking Station is not the Chief Clerk's and/or Clerks', when possible they should be included in the planning of the station or, at the minimum, be allowed to make recommendations since more often than not Meet Management and/or Meet Directors are not aware of what is required to operate a Clerk's Station. However, the following preparations are the responsibility of the Chief Clerk and Clerks and are most essential for the efficient operation of the station:

Post informational signage denoting check-in line for track, field events, specific gender line, time schedule for checking-in/staging/escorting, and event Start Time.

Connect and turn on P.A. system

Get needed basic supplies: pencils, pens, pins, paper clips hip numbers, etc.

Get Start Lists from Competition Secretary or Meet Director.

Compare Start Lists with the Meet Schedule. Check for discrepancies respective to Start Times and number of heats or flights. Report discrepancies to Chief Clerk or Competition Secretary.

Separate Start Lists by Track Events and Field Events then by gender. Arrange separated Start Lists by Start Times as listed on the Meet Schedule.

Check with Meet Director to determine if the athletes will be required to use one or two hip numbers. Prepare hip number sets for each track event and paper clip them to the Start List. Prepare a complete set for each Clerk to have available to replace non-sticking or lost hip number/s.

Synchronize time on Clerk's Station clock with Starter's, Announcer's, and/or TV personnel's watches.



Have blank competition numbers available to replace lost or damaged numbers. Use hip numbers to make up a replacement number.

Prepare a Call Time Schedule which includes Check-in Times (1st, 2nd, 3rd calls) an Report Times and post it by the announcer's mike. Also issue one to each Clerk.

If possible arrange Staging Area benches and/or chairs by heats or flights and number them by lane/position number.

Note: This setup will facilitate lining up the athletes when they report, but it does not diminish the Clerk's responsibility to check the number of athletes reporting versus the number on the Start Lists.

Post Start Lists on a Posting Board if one is available and clearly indicate if the list is a revised one, i.e. dropped or added names, heats or flights added or dropped, athlete's heat, lane, flight changed, or time schedule changed. This information should also be noted on the Check-in Start Lists and the information passed on to the athletes.

Post Clerk's Rotation Schedule.

Have available the applicable rule books for the meet.

## **CONCLUDING COMMENTS**

A Clerk's Station, which has been carefully thought out and planned, will enhance the ability of the Clerks to carry out their duties carefully and expediently. A Clerk's Station should be manned at all times during the day or session. The general rule is that personnel should be assigned from 1/2 hour prior to the check-in time for the first event of the day or session until the last track or field event of the day or session has been checked-in, staged, and escorted to the event. The number of clerks assigned during this period of time is determined by the number of events to be checked-in. A Clerk's primary goal is to facilitate Check-in, Staging, and Escorting for athletes and to ensure that each athlete has been provided the correct competition information. No athlete should ever miss his/her start time because the Clerks preparations were inadequate, they did not follow established procedures, or they relayed inaccurate information to the athlete. For these reasons it is important that each Clerk is updated whenever changes occur and that the changes are made known to the athletes when they check-in or via the P.A. system if one is available. If an athlete is to miss a start time let it be his/her or his/her coaches fault never the Clerks.

It is also important to keep in mind that the Clerk's Station should not be the place to socialize. When entering into a any discussion with an athlete, even one you know personally, be personable, keep your conversation short, and avoid situations which may be construed as your giving preferential treatment to the athlete. Every athlete should be treated fairly and the "Star" athlete should deserve no more of your attention than that you show to the "Upcoming" athlete. Remember that unless it is within your parameter to resolve an athlete's dissatisfaction with the lane, heat, or flight he/she has been assigned, contact the Competition Secretary, Meet Director, or Referee for resolution of the problem. Always follow authority protocol when resolving problems, keep your cool when dealing with negative athletes or coaches, and always maintain a relaxed atmosphere in the Clerk's Station.

Finally, be positive in your attitude toward preparing or assuming your assignment and responsibilities. A positive attitude will be reflected in how efficiently and successful is the operation of the Station. Your attitude toward every meet that you are assigned should be that it is a **MAJOR MEET**. In the milieu of clerking there is no small or large meet, every meet is a "Major Meet" and that your primary goal is to ensure the athletes right to compete fairly and without created complexities which may cause him/her to lose concentration on his/her competition.

# **APPENDIX**

## INDEX

Index	9
Chart A - Clerks Station Layout	10
Chart B - Competition Time Schedule	11
Chart C - Clerks Rotation Cycle	12
Chart D - Recommended Spike Length	13
Chart E - Standard Track Line Colors	14
Chart F - Determining Land Assignments and Forming Heats	15
Chart G - Hurdles Heights	22
Chart H - Track Marking Locations	23
Chart I - Steeple Chase Start Lines	24

# CHART A CLERKING STATION LAYOUT

## TOP VIEW / FLOOR PLAN

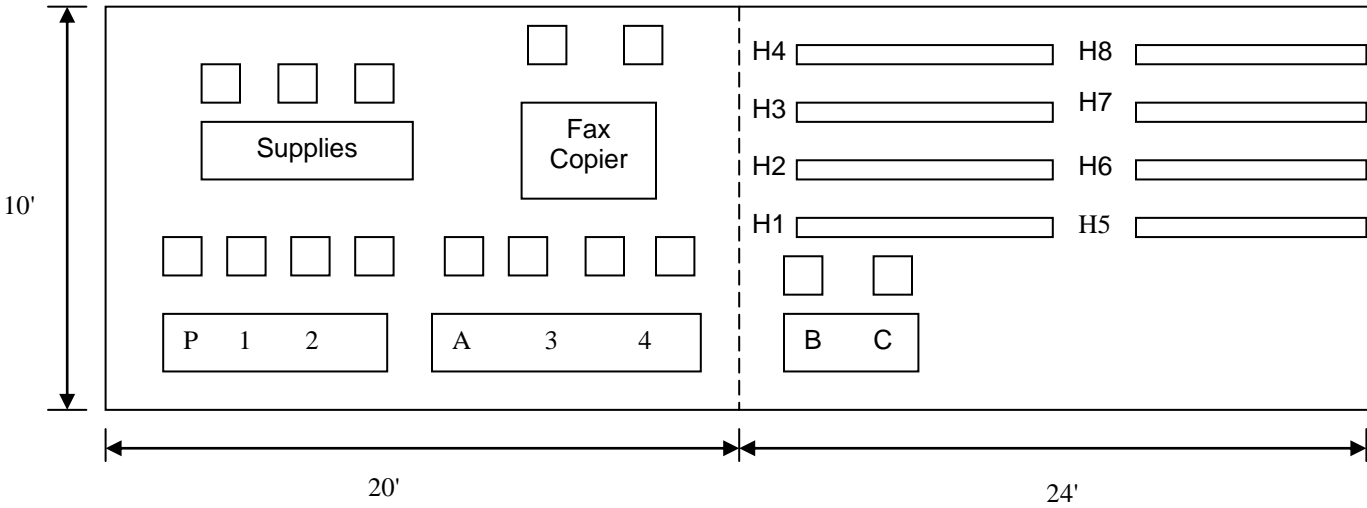

## FRONT VIEW

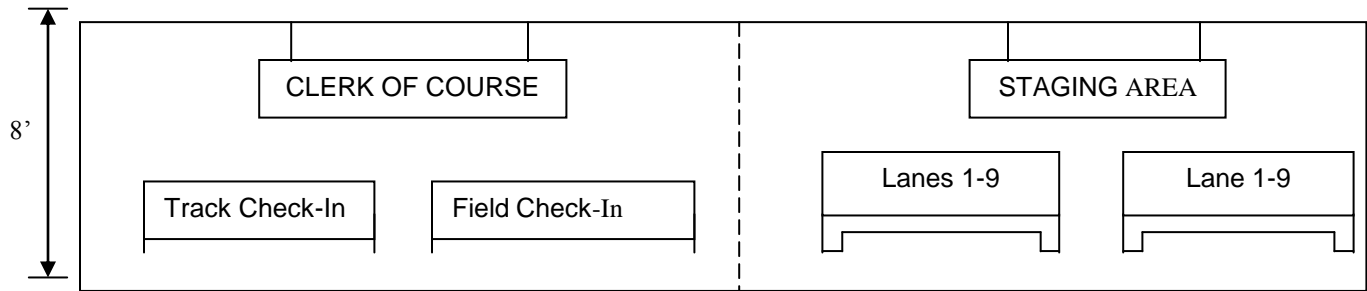

### KEY

- A = Announcer
- B = Staging Clerk/s
- C = Escort Clerk/s
- P = Phone
- 1 = Men's Track Check-in Line
- 2 = Women's Check-in Line
- 3 = Men's Field Check-in Line
- 4 = Women's Field Check-in

### EQUIPMENT

- |  |  |
|--|--|
| <ul style="list-style-type: none"> <li>1. Check-in Tent               <ul style="list-style-type: none"> <li>a. Check-in Tables (2)</li> <li>b. Supply Table (1)</li> <li>c. Chairs (minimum (10) as needed)</li> <li>d. Fax/Copier and Table b. Small Table</li> <li>e. P.A. System</li> <li>f. Phone</li> <li>g. Hand Radio</li> </ul> </li> </ul> | <ul style="list-style-type: none"> <li>2. Staging Tent               <ul style="list-style-type: none"> <li>a. Benches or Chairs</li> <li>c. Chairs (2)</li> <li>d. Audio Hailer</li> <li>e. Hand Radio</li> </ul> </li> </ul> |
|--|--|

### CLERK'S ASSIGNED AREAS

- |   |  |
|---|--|
| <ul style="list-style-type: none"> <li>1. Check-in Tent               <ul style="list-style-type: none"> <li>a. Chief Clerk</li> <li>b. Announcer</li> <li>c. Check-in Clerk/s</li> </ul> </li> </ul> | <ul style="list-style-type: none"> <li>2. Staging Tent               <ul style="list-style-type: none"> <li>a. Staging Clerk/s</li> <li>b. Escort Clerk/s</li> </ul> </li> </ul> |
|---|--|

### MAJOR SIGNAGE NEEDED

- 1. Clerk Of the Course
- 2. Staging Area
- 3. Track Events Check-in
- 4. Field Events Check-in
- 5. Men's Check-in
- 6. Women's Check-in

## CHART B COMPETITION TIME SCHEDULE

ORDER OF EVENTS		OFFICIAL'S		ATHLETE'S				
		Check-in Time	Report Time	Check-in Time	Report Time	Escort Time	Start Time	Round/ # Heat/ # Flights
1	Men's Decathlon 110H	8:00	8:30	9:00	9 30	9 45	10:00	Final/4
2	Men's Decathlon Discus						10:45	Final/2
3	Women's Heptathlon Long Jump						11:00	Final/2
4	Women's Heptathlon Javelin						2:30	Final/2
5	Men's Decathlon Pole Vault						1:30	Final/2
6	Men's Discus	1:00	12:30	1:00	1:30	1:40	2:30	Trial/3/ Final
7	Women's Heptathlon 800m	1:00**	1:30**	2:00**	2:30**	2:45**	3:00	Final/2
8	Men's Triple Jump	NA	NA	2:30	3:00	3:10	4:00	Trial/2/ Final
9	Women's 200m	4:00	4:30	5:00	5:30	5:45	6:00	Semi/2
10	Men's 200m	NA	NA	5:15	5:45	6:00	6:15	Semi/3

\* At most meets the Multi-event Coordinator assumes responsibility for checking-in the athletes for the field events after they have initially checked-in for the first track event of the day. The Coordinator keeps the Clerks informed of the progress of the competition and if any athlete withdraws from the competition. This information is also relayed to the Seeding Coordinator so that the last track event of the day can be reseeded.

\*\* Generally the athletes check-in with the Clerks for the last track event of the day's competition. However, under adverse weather conditions or if the Clerk's location is at a distance from the stadium proper, the Chief Clerk in agreement with the Multi-events Coordinator may work out a different system for checking-in the athletes and issuing them their hip numbers. This may include meeting the athletes in an area in close proximity to the starting line.

NOTE: The start time for the Decathlon Discus, Pole Vault, Javelin and the Heptathlon Javelin are approximations, the actual start times can not begin until 30 min. after the completion of the previous event.

## CHART C CLERK'S ROTATION CYCLE

**KEY:**

Number	Assignment
1	Announcer
2	Check-in, Field Events
3	Check-in, Track Events/Multi-events*
4	Staging Area
5	Escort
6	Escort
7	Escort
8	Line Clerk/Starter's Assist.
9	Substitution/Free Time

\* Check-ins for Multi-events athletes may be assigned to the Field Events Clerk if the Track Events check-in Clerk is checking-in Track Events at the time when the Multi-events athletes have to check-in.

### ROTATION CYCLE

Name	1st	2nd	3rd	4th	5 <sup>th</sup>	6th	7th	8th	9th	10th
Amos Smith	1	9	8	7	6	5	4	3	2	1
Ann Smith	2	1	9	8	7	6	5	4	3	2
Ca1 Smith	3	2	1	9	8	7	6	5	4	3
Dan Smith	4	3	2	1	9	8	7	6	5	4
Fred Smith	5	4	3	2	1	9	8	7	6	5
Jane Smith	6	5	4	3	2	1	9	8	7	6
Mary Smith	7	6	5	4	3	2	1	9	8	7
Roger Smith	8	7	6	5	4	3	2	1	9	8
Zane Smith	9	8	7	6	5	4	3	2	1	9

**NOTE:** The rotation cycles can be based on a time factor (each rotation is in effect for a specific period of time) or a number of events factor (the rotation is in effect for a specific number of events a specific number of event checked-ins. Rotation cycles based on a specific number of check-ins is the probably the best system to utilize since the rotation takes place after an event check-in has been completed.

### SAMPLE ROTATION BASED ON A TIME FACTOR

1st Day Rotation		2nd Day Rotation		3rd Day Rotation	
#	Time Period	#	Time Period	#	Time Period
1	7:30am - 11:00am	5	8:00am - 11:00am	9	8:30am - 12 Noon
2	11:00am - 2:30pm	6	11:00am - 2:30pm	10	12 Noon - 3:00pm
3	2:30pm - 6:00pm	7	2:30am - 6:00pm		
4	6:00pm - 9:30pm	8	6:00pm - 9:15pm		

### SAMPLE ROTATION BASED ON EVENT CHECK-IN TIME FACTOR

1st Day Rotation		2nd Day Rotation		3rd Day Rotation	
#	Event Check-in	#	Event Check-in	#	Event Check-in
1	M Hammer-Hept Jav	5	W Hammer-M Jav	9	W 10,000RW-M 110H
2	Deca PV-M 3000SC	6	M PV-M 400H	10	M Jav-W HJ
3	Deca Jav-W 100	7	W PV-M Discus		
4	M 100-M 10,000	8	W1500-W10,000		

## CHART D

### RECOMMENDED SPIKE LENGTHS

Events	Outdoor	Indoor
<u>Track</u>		
0 - 400m	3/16" or 1/4" Christmas Tree (5-7 mm)	3/16" Christmas Tree (5 mm)
800m - 1,500m	1/4" Pyramid (7 mm)	1/8" or 3/16" Pyramid (3-5 mm)
3,000m - 10,000m	3/16" Pyramid (5mm)	1/8" or 3/16" Pyramid (3-5 mm)
<u>Cross Country</u>		
	3/8" or 1/2" Pyramid (9-12 mm)	N/A
<u>Field</u>		
Javelin	1/2" Pyramid (9 mm)	N/A
High Jump	1/4" Pyramid (7 mm)	N/A
Long Jump	1/4" Pyramid (7 mm)	N/A

Inch	Equiv. mm	Uses	Pyramid	Needle	Christmas Tree	Specialty
0	0	Blanks				Blanks
1/8	3	For indoor and thin synthetic tracks	Yes	Yes		Camlock
3/16	5		Yes	Yes	Yes	
1/4	7	For most outdoor synthetic tracks and field events	Yes	Yes	Yes	Tartan
3/8	9	For thicker urethane tracks, XC	Yes	Yes		
1/2	12	For javelin, High Jump and non synthetic tracks, XC	Yes			
5/8	15	For non synthetic surfaces	Yes			
1	25	For non synthetic surfaces	Yes			Javelin

On outdoor synthetic surfaces the IAAF and USATF allows spikes of 4 mm diameter and up to 9 mm length for the part that is above the shoe surface in all event but high jump and javelin where it allows 12 mm long spikes. On non synthetic surfaces the maximum length is 25 mm long. spikes with a maximum diameter of 4 mm. USATF have the further restriction that on synthetic surfaces, that the meet organizers may set the spike length. For indoor tracks the IAAF has a maximum length of 6 mm for all events.

Spikes normally come in needle or slim point, pyramid or specialty shapes such as Christmas Tree, Tartan or Steelex spikes. They are usually made of steel but can be made of aluminum. Colored spikes are made by Omni Lite of ceramic aluminum. Some have flat sides like the pyramids, needle and tartan and others hex sides.

## CHART E STANDARD TRACK COLORS

### ynthetic Tracks(IAAF)

White	All lane lines, all starts and 400 m staggered start, all curved starts, all finish lines.
White w Green	800 m Staggered Start
White w Blue	4x400 Staggered Start
Green	Break Lines
Light Blue	4x400 Relay Zones
Yellow	4x100 Relay Zones
Orange	4x100 Acceleration

### Other Hurdle Positions (if needed)

Green	400 m Hurdle	Pink	70 m Hurdle
Blue	110 m Hurdle	Orange	75 m Hurdle
Yellow	100 m Hurdle	Black	80 m Hurdle
Red	Call up Lines	Purple	200 m Hurdle (Men)
		White	200 m Hurdle (Women)



## CHART F DETERMINING LANE ASSIGNMENTS AND FORMING HEATS

Normally with use of the new computer programs the Clerk or the Competition Secretary will set up heats and lane assignments. However, in smaller meets and/ when changes occur it is sometime necessary that the clerk apply the rules for forming heats or at least be able to verify that the redraw was done correctly.

Preliminary races are used to narrow the field of competitors for an orderly and fair final competition. Contestants will be assigned to preliminary heats in order in which their names are listed on the performance list. They are assigned by working alternately from left to right and right to left. Lane assignments are drawn by lot for events run entirely or partially in lanes when quarterfinals or semifinals are needed. For the longer distances events the following table should be used in determining the heat size and final number of competitors assigned to each heat:

DISTANCE	NUMBER REPORTING	MAXIMUM NUMBER OR IN THE FINAL
1,500	17	12
3,000	13	14
5,000 Men's	21	16
5,000 Women	25	20
10,000	25	SECTIONS NOT MORE THAN 20

The following procedures are used in forming heats and drawing for lanes in races up to and including the 800 meter run and in relays up to and including 4x400. Central to forming heats is to weigh "place: first and "time" second. Each group of place winners is seeded as a unit by their times: first seeding winners, then second-place runners, etc. If two runners from the same team fall within the same heat, the slower person should be moved to another heat. Lanes are drawn by lot in the first round. For all other rounds, two draws will be made. The first draw is for athletes with the four best times in each heat or race, in order to determine the assignments for lanes 3, 4, 5 and 6. The second draw is for athletes with the four slowest times of those qualifying in each heat or race. It is used to determine the assignments for lanes 1, 2, 7 and 8. Review the procedure in each book since each is slightly different. Most have detailed examples. Generally at least two places in each heat should advance. The intent is that the best competitor make it to the finals.

If the Games Committee in a USATF meet determines that there are too many competitors to run a single final, the event shall be contested in sections as a time-based final. In such events, sections shall be derived from the ranked list of declared athletes, arranged in order of qualifying times. Each section, beginning with the fastest, shall be filled to its limit before placing anyone into the next section. If the last section has less than three competitors, the slowest ranked competitor(s) from the previous section, as needed, shall be moved to that section. Sections shall be contested in reverse order, slowest to fastest.

## TRIALS

### 1. Declared contestants listed by best performance:

*Fastest*

*Slowest*

1-2-3-4-5-6-7-8-9-10-11-12-13-14-15-16-17-18-19-20-21-22-23

### 2. Heats are formed using serpentine assignments of competitors (left to right, right to left)

Heat #1	Heat #2	Heat #3
1	2	3
6	5	4
7	8	9
12	11	10
13	14	15
18	17	16
19	20	21
	23	22

**Assigning Lanes**  
Draw by lot for all  
lanes within each  
heat.

### 3. Competitors qualify to advance by taking places 1 through 4 from each heat plus the next four fastest times.

---

## SEMI-FINAL

### 1. Weighing place first in filling lanes and then filling remaining lanes by time; seed all winners first by time, then second place finishers, . . . etc.-- working left to right and then right to left (i.e., serpentine).

Winners	Second Placers	4t	5t	Remaining
1a = fastest 1st place finisher	2a = fastest 2nd place finisher	3rd	h	h
1b = second fastest 1st place finisher	2b = second fastest 2nd place finisher	3a	4a	5a
1c = third fastest 1st place finisher	2c = third fastest 2nd place finisher	3b	4b	5b
		3c	4c	5c

### 2. Heats are formed using serpentine assignments of competitors (left to right, right to left)

USATF National Officials Committee and Pacific Association Training Monograph Series

Heat #1	Heat #2
1a	1b
2a	1c
2b	2c
3b	3a
3c	4a
4c	4b
5a	5b
N1	5c

### Assigning Lanes

(for each heat)

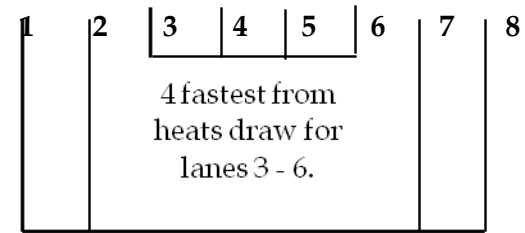

4 slowest from each heat are drawn for lanes 1, 2, 7 and 8.

---

### FINAL

1. Qualify for the finals by taking the first four placers from each heat.
2. Draw lanes by lot; assigning four fastest finishers to lanes 3, 4, 5 and 6; and the four slowest to lanes 1, 2, 7 and 8.

---

### Assigning Lanes

(for each heat)

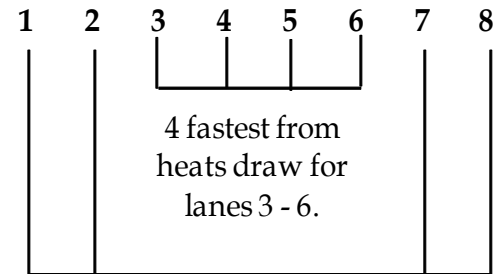

4 slowest from each heat are drawn for lanes 1, 2, 7 and 8.

---

## Seeding Procedure Example

As NTO you received the following results to verify who qualified and in which heats they will run in the semi-final round. Use Q for automatic qualifiers and q for time qualifiers. Explain any problems you see.

<b>Result - 4 X 100 METRES Men - Heats</b>									
Qual. rule: first 3 of each heat (Q) plus the 4 fastest losers (q) qualified									
<b>Heat 1 - Saturday, August 11, 2001 - 15:00</b>									
						Who	Semi-Final		
Lane	Team	Country	2001	Personal	Results	Qualified	Heat	Lane	
2	Poland	POL	38.84	38.33	38.79				
3	Brazil	BRA	38.67	37.90	38.44				
4	Benin	BEN			DNS				
5	Venezuela	VEN		39.45	DQ				
6	Trinidad & Tobago	TRI		38.92	38.60				
7	Thailand	THA	39.18	38.8	DQ				
<b>Heat 2 - Saturday, August 11, 2001 - 15:10</b>									
Lane	Team	Country	2001	Personal	Results	Qualified	Heat	Lane	
2	France	FRA		37.79	38.97				
3	Germany	GER	38.99	38.58	DQ				
4	Belgium	BEL	39.52	39.48	39.16				
5	Japan	JPN	38.93	38.31	38.67				
6	United States	USA	38.19	37.40	38.35				
7	Nigeria	NGR		37.91	39.10				
8	Liberia	LBR		39.77	DNF				
<b>Heat 3 - Saturday, August 11, 2001 - 15:20</b>									
Lane	Team	Country	2001	Personal	Results	Qualified	Heat	Lane	
2	Jamaica	JAM		38.20	40.05				
3	Italy	ITA		38.37	38.97				
4	Australia	AUS		38.17	38.96				
5	Saudi Arabia	KSA		39.45	39.15				
6	Canada	CAN	38.93	37.69	38.83				
7	Bahamas	BAH		39.09	39.16				
<b>Heat 4 - Saturday, August 11, 2001 - 15:30</b>									
Lane	Team	Country	2001	Personal	Results	Qualified	Heat	Lane	

2	Ivory Coast	CIV		38.73	38.74			
3	Mauritius	MRI		39.19	38.99			
4	Israel	ISR		38.81	39.13			
5	Cuba	CUB		38.00	DNF			
6	Cameroon	CMR		39.25	39.29			
7	Great Britain & N.I.	GBR		37.73	DNF			
8	South Africa	RSA		38.50	38.72			
<i>Copyright © 1996-2001.</i>								
<i>IAAF International Amateur Athletic Federation. All rights reserved.</i>								

1. Determine number of heats

For individual races up to and including 800 m and relays up to an including 4x400 the number of competitors at start shall not exceed the number of lanes on the track for that event, excluding all lanes that would not qualify for record purposes (166.1a). An exception can be in first round of 800m where up to 12 may start using two waterfall start lines. Generally no less than 3 athletes from any heat shall advance to the next round.

For 1500m and longer the Games committee will determine the number of heats , the number of qualifiers and the basis for qualification based on

- a. At least half of qualifiers for a succeeding round shall be on the basis of place and no more than half on time.
- b. If more than 16 in 1500m more than 18 for 3000 m Steeplechase, or more than 20 for 5000m (except Women's 5000) heats shall be run.
- c. If heats then no more than 12 to finals in 1500m, no more than 14 in finals of 3000m or steeplechase and no more than 16 in final of 5000m.
- d. If more than 24 report for 10000m or open Women's 5000m then run in sections of no more than 24 or in heats of no more than 24 with no more than 20 advancing to finals of 10000 and no more than 16 in the 5000.
- e. Other than Open Nationals, Games Committee may elect to use sections but if so must so state in entry form.

2. Based on table in Rule 166 or 303 (Youth) or special circumstances in 332 (Masters) determine how many will move on based on place and time.

3. Four Steps to forming Heats:

**A. Determine who is qualified by preparing ranked list**

**Round 1** including sections:

From ranked list of qualified and declared athletes based on qualifying times. If no time then randomly after ranked. If qualifying more than 12 mo. then current year time then other times then no times.

**Other Rounds**

- a. For events **up to and including 400m and relays up to and including 4x400** seeding based on list of competitor who advance on place followed by advance on time. Order each heat by place. Then combine so best first, second best first, etc. followed by best second, second best second, etc. and best third et and then best not placing time for number of times that qualify. Use only one system (auto or hand) of timing.
- b. For **all other events**, seeding is from list ranked by original qualifying times rearranged only if time improvements in previous rounds.

**B. Assign athletes to heats**

Assign athletes from ranked list determined in A. working alternately from heat 1 (left) to heat x (right) and then from Heat x to Heat 1 in zig zag fashion until all are assigned.

If this creates a heat that contains the fastest times from each place group, i.e. fastest first, fastest second and fastest third etc. the same list is used but heat assignment for the fastest time in each place group is alternated. See 4 heats 4 qualifiers in example below. Note no team affiliation consideration is used. (Different from IAAF where countries are kept separate as long as you can)

Note if all heats don't have the same number of athletes when finished then heats for extra athletes are draw by lot.

**Examples of forming heats:**

Legend:

1a - Fastest First-Place Runner

1b - Second Fastest First-Place Runner, etc.

2a - Fastest Second-Place Runner

2b - Second Fastest Second-Place Runner, etc.

(concluding with)

5a - Fastest Time Qualifier

5b - Second Fastest Time Qualifier, etc.

3 Heats, 4 Qualifiers on Place, 4 on Time		4 Heats, 4 Qualifiers on Place		5 Heats, 3 Qualifiers on Place	
Heat 1	Heat 2	Heat 1	Heat 2	Heat 1	Heat 2
1a	1b	1a	1b	1a	1b
2a	1c	1d	1c	1d	1c
2b	2c	2b	2a	1e	3a
3b	3a	2c	2d	2c	2b
3c	4a	3a	3b	2d	2e
4c	4b	3d	3c	3b	3a
5a	5b	4b	4a	3c	3d
5d	5c	4c	4d	3e (by lot)	

**C. Assign order to heats by drawing by lot.**

**D. Assign athletes to lanes**

Principles of assigning lanes

a. For events **100 to 800m inclusive and relays up to and including 4x400**

**Round 1** (including final if only round), drawn by lot using designation of lanes by Games committee.

**Other Rounds:** Two draws normally one for top 4 usually 3-6 and one for rest, namely 1,2,7,8.

b For **non lane start races** for all rounds position on track drawn by lot

**ANSWER**

Since it is less than 4x400, and we have 26 teams and given qualifying rule is 2 semi final with first 3 plus 4 best times advance under IAAF rules.

Heat	First	Second	Third	Fourth	Fifth	Sixth
1	<b>Brazil 38.44</b>	<b>Trinidad &amp; Tobago 38.60</b>	<b>Poland 38.79</b>	None	None	
2	<b>USA 38.35</b>	<b>Japan 38.67</b>	<b>France 38.97</b>	Nigeria 39.10	Belgium 39.16	
3	<b>Canada 38.83</b>	<b>Australia 38.96</b>	<b>Italy 38.97</b>	Saudi Arabia 39.15	Bahamas 39.16	Jamaica 40.05
4	<b>South Africa 38.72</b>	<b>Ivory Coast 38.74</b>	<b>Mauritius 38.99</b>	Israel 39.13	Cameroon 39.29	

Tie for 16th position so need times to 1000th to determine which one advances.

Ordered list

Country	Time	Place	Qualify	Heat	Lane
---------	------	-------	---------	------	------

USA	38.35	1a	Q	A	3-6
Brazil	38.44	1b	Q	B	3-6
South Africa	38.72	1c	Q	B	3-6
Canada	38.83	1d	Q	A	3-6
Trinidad & Tobago	38.60	2a	Q	A	3-6
Japan	38.67	2b	Q	B	3-6
Ivory Coast	38.74	2c	Q	B	3-6
Australia	38.96	2d	Q	A	3-6
Poland	38.79	3a	Q	A	1-2,7-8
France	38.97	3b	QT	B*	1-2,7-8
Italy	38.97	3c	QT	B*	1-2,7-8
Mauritius	38.99	3d	Q	A	1-2,7-8
Nigeria	39.10	13th	q	A	1-2,7-8
Israel	39.13	14th	q	B	1-2,7-8
Saudi Arabia	39.15	15th	q	B	1-2,7-8
Bahamas	39.16	16T	q	A Best time to 1/1000	1-2,7-8
Belgium	39.16	16T			

\*Doesn't matter whether France or Italy is in 10th place since both will be in Heat B in outside lanes. But if you want to determine it then the best time to 1/1000th would indicate which one is in 11th place. If France is 38.965 and Italy is 38.966 then order shown is correct.

If had more than one heat then assign as follows:

<b>Heat A</b>	<b>Heat B</b>
<b>Lanes 3-6</b>	<b>Lanes 3-6</b>
USA	Brazil
Canada	South Africa
Trinidad & Tobago	Japan
Australia	Ivory Coast
<b>Lanes 1-2,7-8</b>	<b>Lanes 1-2,7-8</b>
Poland	France
Mauritius	Italy
Nigeria	Israel
16 Tie1*	Saudi Arabia

\* Must read photo to third decimal to determine which team makes the semi final.

Draw for lanes in 4 groups i.e. Heat A first 4 for lanes 3-6, Heat B first 4 for lanes 3-6 Heat A second 4 for lanes 1-2,7-8 and Heat B second 4 for lanes 1-2,7-8 once 16th place is settled.

## CHART G HURDLE SPACING

### DON'T SURPRISE A HURDLER

Everyone loves a hurdle race and here is how you set up the hurdles so you do not surprise the hurdlers.

RACE METERS	AGE/DIVISION	NO. OF HURDLES IN RACE	HURDLE HEIGHT	DISTANCE TO FIRST HURDLE	DISTANCE BETWEEN HURDLES	DISTANCE TO FINISH
50	Women	4	33"	13.00 m	8.50 m	11.50 m
50	Men	4	42"	13.72 m	9.14 m	8.86 m
55	Women	5	33"	13.00 m	8.50 m	8.00 m
55	High School Boys	5	39"	13.72 m	9.14 m	4.72 m
55	Men	5	42"	13.72 m	9.14 m	4.72 m
60	Masters Women W60+/Masters Men M80+	5	27"	12.00 m	7.00 m	20.00 m
60	Masters Women W50-W55/Masters Men M70-M75	5	30"	12.00 m	7.00 m	20.00 m
60	Masters Women W40-W45	5	30"	12.00 m	8.00 m	16.00 m
60	Women/Masters Women W30-W35/Masters Men M60-M65	5	33"	13.00 m	8.50 m	13.00 m
60	Masters Men M50-M55	5	36"	13.00 m	8.50 m	13.00 m
60	Masters Men M30-M45	5	39"	13.72 m	9.14 m	9.72 m
60	Men	5	42"	13.72 m	9.14 m	9.72 m
75	High School Girls	7	30"	13.00 m	8.50 m	11.00 m
80	Master Women 60+/Master Men 80+	8	27"	12.00 m	7.00 m	19.00 m
80	Midget Girls & Boys	8	30"	12.00 m	7.50 m	15.50 m
80	Masters Women W50-W59/Master Men M70-M75	8	30"	12.00 m	7.00 m	19.00 m
80	Masters Women W40-W45	8	30"	12.00 m	8.00 m	12.00 m
100	Youth Girls	10	30"	13.00 m	8.00 m	15.00 m
100	Int. Girls/Young Women/Women/Youth Boys/ Masters Women W30-W35/ Master Men M60-M65/High School Girls	10	33"	13.00 m	8.50 m	10.50 m
100	Experimental Women USATF/ Masters Men M50-M55	10	36"	13.00 m	8.50 m	10.50 m
110	Intermediate Boys/Young Men/High School Boys/ Masters Men M30-M45	10	39"	13.72 m	9.14 m	14.02 m
110	Men	10	42"	13.72 m	9.14 m	14.02 m
200	Youth Boys & Youth Girls	5	30"	20.00 m	35.00 m	40.00 m
300	Masters Women 60+/Master Men 70+	7	27"	50.00 m	35.00 m	40.00 m
300	Masters Women W50-W55/Master Men M60-M65	7	30"	50.00 m	35.00 m	40.00 m
300	High School Girls	8	30"	45.00 m	35.00 m	10.00 m
300	High School Boys	8	36"	45.00 m	35.00 m	10.00 m
400	Intermediate Girls/Young Women/Women Masters Women W30-W45	10	30"	45.00 m	35.00 m	40.00 m
400	Masters Men M50-M55	10	33"	45.00 m	35.00 m	40.00 m
400	Intermediate Boys/Young Men/Men/ Masters Men M30-M45	10	36"	45.00 m	35.00 m	40.00 m

**NOTE:** To find the Start and Finish line for a 200 Intermediate Hurdle and a 300 Intermediate Hurdle race when you know the 400 Intermediate Hurdle markings follow these directions:

- ❖ Start with the last hurdle in your race and count back the number of hurdles in the race +1
- ❖ Measure back 10 meters from the first hurdle minus the +1 hurdle
- ❖ Remove hurdle 1 minus the + 1 hurdle minus leaving the number of hurdles you want for the race in the first place and now have 45 meter to the first race hurdle.
- ❖ Measure from the last hurdle to the finish line and enjoy your race.



## CHART H

### LOCATION OF TRACK MARKS:( 400 Meter Track)

Mark	<u>Entire Track</u>			<u>Last 110 Meters</u>	
	Distance (meters)			Distance (meters)	
	From	To		From	To
	Start	Finish		Start	Finish
Start /Finish/400/10000	0	400	400H-8/3rd X Zone Start/(Start 110)	290	110
4th X Zone End	10	390	Start 100/3rd X Zone Center	300	100
400H-1	45	355	110H-1	303.72	96.28
440H-2/4th Zone Fly-Start	80	320	3rd X Zone End	310	90
1st X Zone Start	90	310	110H-2	312.86	87.14
Start 300/1500/1st X Zone Center	100	300	100H-1	313	87
1st X Zone End	110	290	300H-6/Start 80	320	80
400H-3	110	285	100H-2	321.5	78.5
300H-1	145	255	110H-3	322	78
400H-4	150	250	400H-9	325	75
300H-2/2nd Zone Fly-Start	180	220	100H-3	330	70
400H-5	185	215	110H-4	331.14	68.86
2nd X Zone Start	190	210	80H-1	332	68
Start 200/3000/5000/2nd X Zone C	200	200	100H-4	338.5	61.5
2nd X Zone End	210	190	80H-2	339.5	60.5
300H-3	215	185	110H-5	340.28	59.72
400H-6	220	180	100H-5/80H-3	347	53
300H-4	250	150	110H-6	349.42	50.58
400H-7	255	145	80H-4	354.5	45.5
3rd Zone Fly Start	280	120	300H-7	355	45
300H-5	285	115	100H-6	355.5	44.5
400H-8 3rd X Zone Start	290	110	110H-7	358.56	41.44
Start 100/3rd X Zone Center	300	100	400H-10	360	40
3rd X Zone End	310	90	80H-5	362	38
300H-6	320	80	100H-7	364	36
400H-9	325	75	110H-8	367.70	32.30
300H-7	355	45	80H-6	369.5	30.5
400H-10	360	40	100H-8	372.5	27.5
4th Zone Fly Start	380	20	110H-9	376.84	23.16
300H-8/4th X Zone Start	390	10	80H-7	377	23
Finish/Start	400	0	4th Fly Start	380	20
			100H-9	381	19
			80H-8	384.5	15.5
			110H-10	385.98	14.02
			100H-10	389.5	10.5
			300H-8/Start 4th X Zone	390	10
			Finish/Start	400	0

Note: 200 m Stagers are 3.518 meters for lane 2 and 3.833 meters for remaining lanes. Use twice the figure for 400 meter stagers with 1.220m(48")lanes and 36.5 meter radius and 84.390 meter straight-aways. These, of course, vary with lane width and track layout.

# 2000 METERS STEEPLE CHASE START and FINISH LINES

1. WATER JUMP LOCATED AT SAME END AS COMMON FINISH LINE

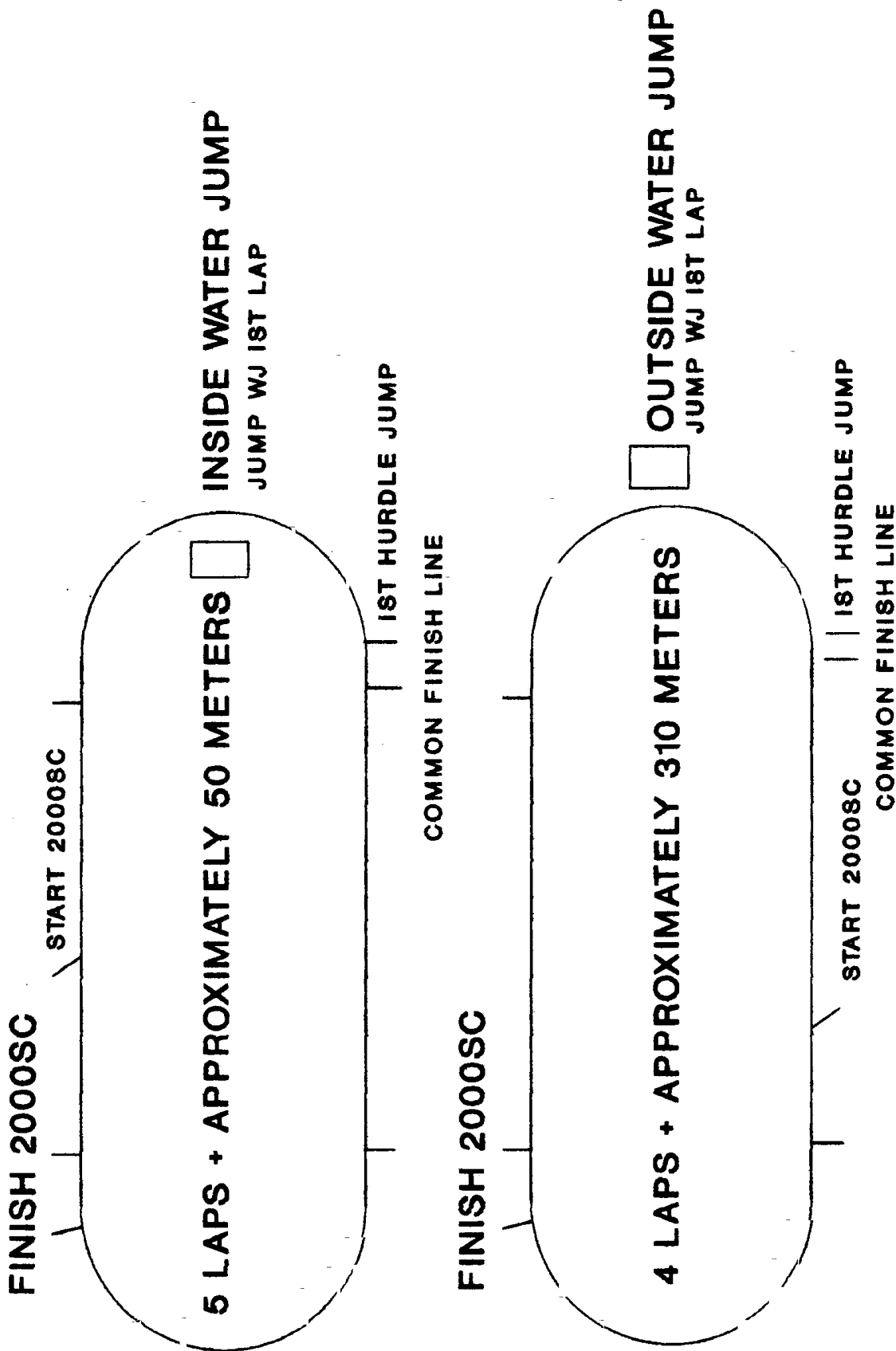

L.G. COSTANZO, SCTFOC 6/1/94

**2. WATERJUMP AT OPPOSITE END OF TO COMMON FINISH LINE**

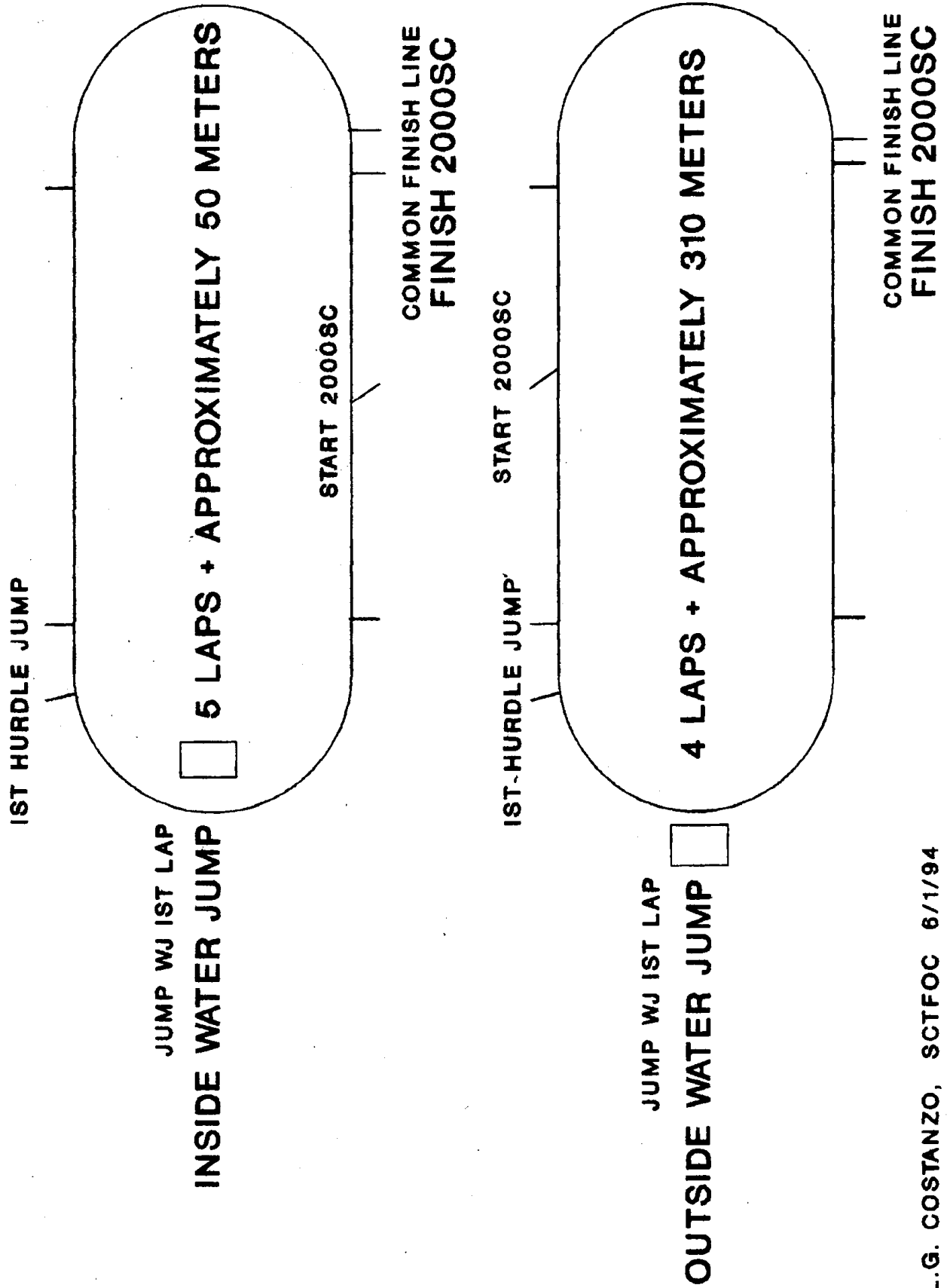

# 3000 METERS STEEPLECHASE START and FINISH LINES

1. WATER JUMP LOCATED AT SAME END AS COMMON FINISH LINE

FINISH 3000SC  
1ST HURDLE JUMP

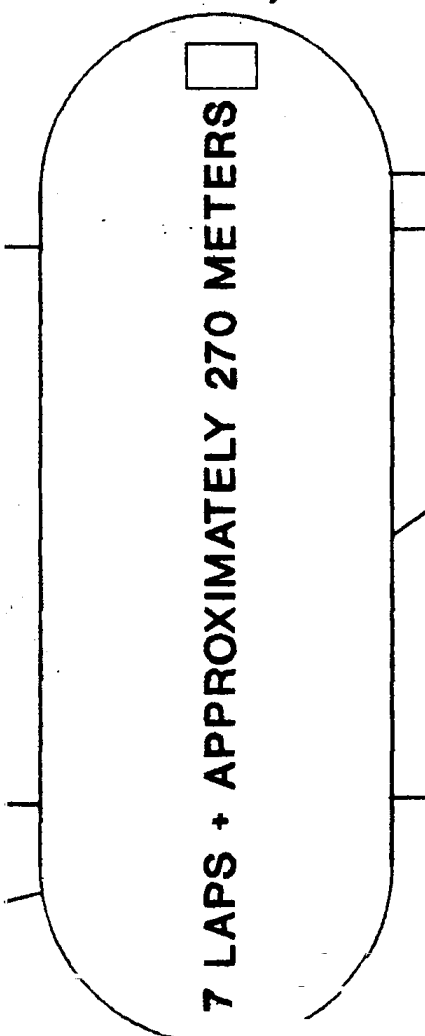

INSIDE WATER JUMP  
JUMP WJ 2ND LAP

FINISH 3000SC  
1ST HURDLE JUMP

START 3000SC COMMON FINISH LINE

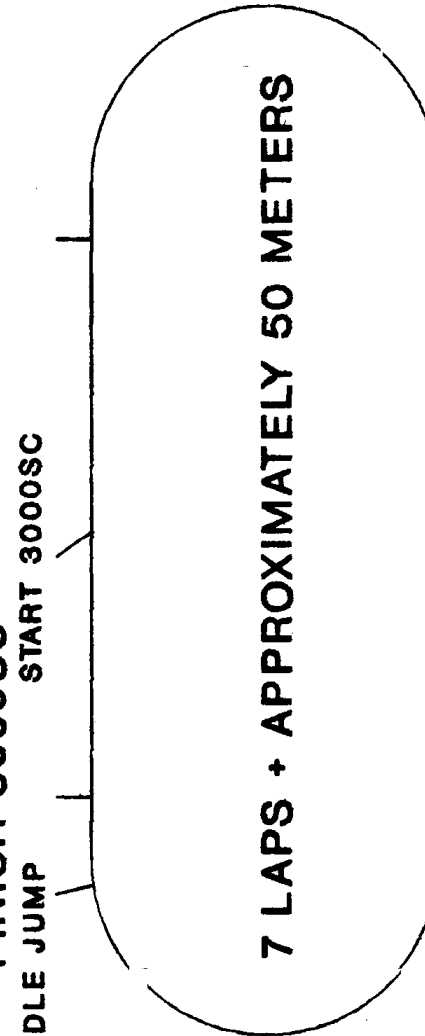

7 LAPS + APPROXIMATELY 50 METERS

OUTSIDE WATER JUMP  
JUMP WJ 1ST LAP

L.G. COSTANZO, SCTFOC 6/1/94

COMMON FINISH LINE

**2. WATER JUMP LOCATED AT OPPOSITE END TO COMMON FINISH LINE**

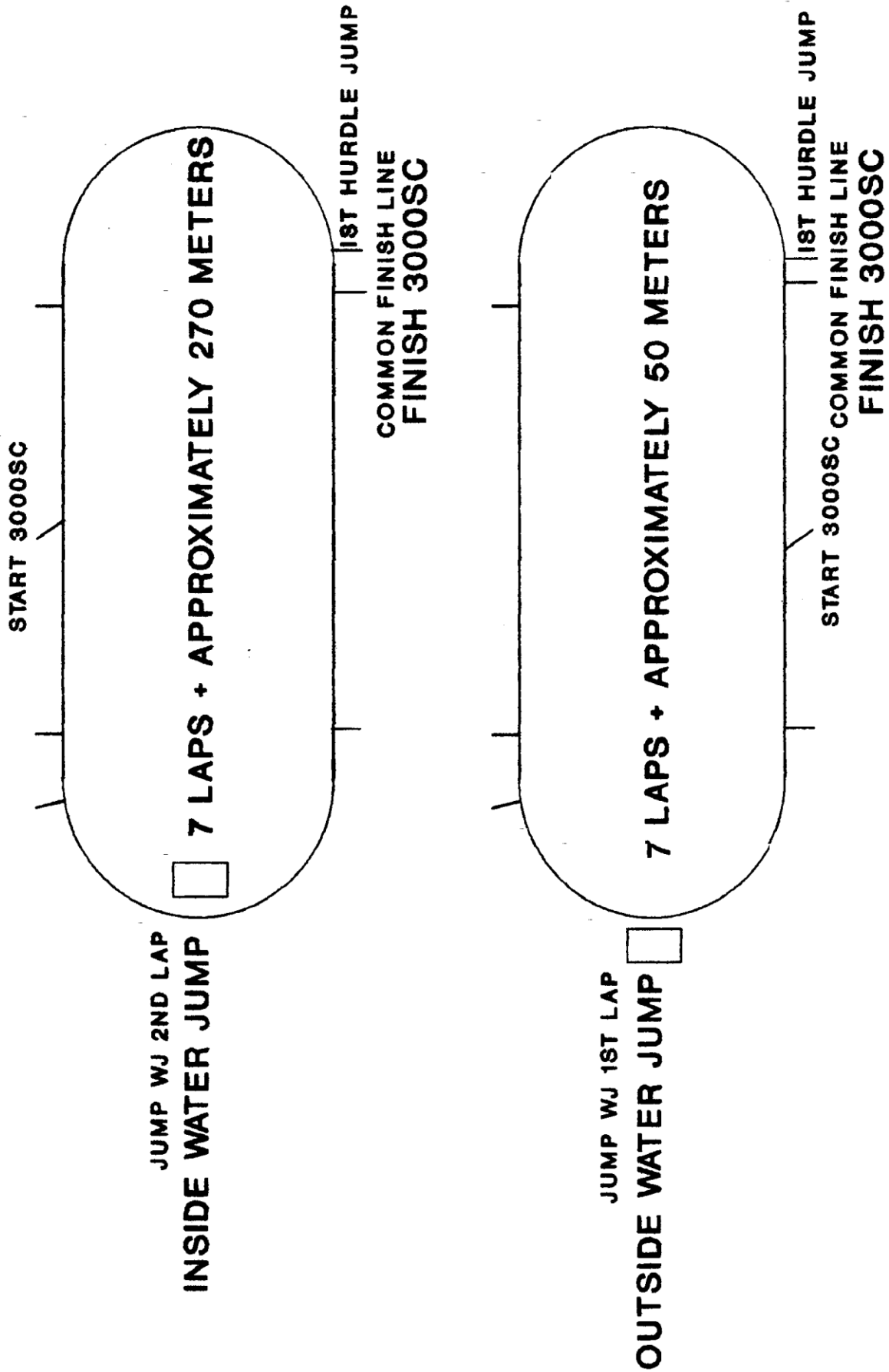

L.G. COSTANZO, SCTFOC 6/1/94