

# THE THROWING OFFICIALS' MANUAL



**Compiled By**

**George Kleeman, Pacific**

**2007**

This manual is part of the USATF National Officials Monograph Series on how to officiate and the Pacific Association Training . Each monograph covers the various techniques for each officiating assignment. These monographs are intended for more in depth understanding of each job. They are intended for both the novice and seasoned official. They cover the real details of the job and how it should be performed. They summarize various techniques to accomplish the job. These monographs can be copied and used for officials training only

**USATF National Officials Committee Training Monograph Series**

# Index

Subject	Page
Index	i
Introduction	1
Safety	2
Definitions	3
<b>Rules</b>	4
Number of Trials/Contestants	4
Ties/Places	4
Call Up/Timing/Absences	4
Aid/Coaching	6
Warm-up	7
Facilities	8
Circles/Runways	8
Set Up	8
Use of Flags/Verbal Commands	9
Competition/Form Requirements	9
Measurements	10
Fouls	10
Disqualification	11
Applicable Major Rule References	12
<b>Officials</b>	13
Proactive Officiating/Problem Solving and Avoidance	13
General	13
Number and Priority of Officials	13
Duties	15
Marching Order	17
<b>Step by Step Activities</b>	17
Before Competition	17
Day Of Competition	17
Warm-up	18
Instructions	19
Throwing Competition	20
Marking Throws	21
Measurement	22
Continuing Competition	24
After Competition	24
Suggested Personal Equipment for Throwing Officials	24
Appendix	
Appendix A Implements	27
Weights and Measures	27
Appendix B Venue and Sector Layout	31
Sector Layout and Dimensions	31
Venue Layout	33
Discus	33
Hammer	34
Javelin	35
Shot	36

## OVERVIEW OF OFFICIATING THROWING EVENTS

### INTRODUCTION:

This monograph is intended for the new as well as the seasoned veteran throwing official. It includes all you need to know about how to officiate a throwing event at any level including the specifications for the implements. It is intended to be a "how to officiate the event" in a practical sense. It is broken down into three general sections. The first is the rules, the second deals with officials and their assignments, and the third covers the conduct of the event itself in time sequence. There are several appendices, which cover Implement Specifications and Venue Set Up. George Kleeman wrote this monograph with past contributions from Keith Mitchell of the Indiana Association, and Gail Wetzork of the Pacific Association. It is a summary of the current best practices in the United States. It is not intended to be a cookbook but rather a compendium of various methods that can be used. Use what works best for you and your location.

The throwing events include the hammer, the weight, the discus, the shot and the javelin. The first four are thrown from a circle and the last from a runway terminated by an arc. When officiating in any of the throwing events keep safety in mind first and always. This is safety for you, your officials and your athletes as well as other officials and athletes that could be impacted by your event. This aspect is covered more fully in a section below. Because we are involved with throwing things, we cause problems. Note the rules for the Masters Superweight and Ultraweight event are the same as for the weight which are the same as for the hammer.

Field events, particularly the throws, require athletes to combine the talents of speed, strength and control. The field official must focus on the details of equipment specifications, time constraints for trials, and accurate and consistent measurement. The throwing events are special field events because they include the use of implements which must be measured and checked to make sure that they conform to requirements before the event. Consequently as a throwing event official you will have to know something about the weighing and measuring of the implements. Generally the athletes supply implements. Only in the biggest meets does the Games Committee supply all the implements.

Not all of the throwing events are contested at each level. Some high school invitational competitions, particularly in Rhode Island, California and Washington, have begun to include the hammer. It is now part of the Youth and Junior Olympic programs at the national level. The javelin is a high school event in only about 14 states although it is thrown in the local USATF youth programs. The weight is normally thrown indoors but can be contested outdoors. Implement specifications for all of the throwing events are generally available in the USATF rules. Likewise the USATF Equipment and Facilities Specifications Committee, which is a subcommittee of the National Official Committee, publishes a Weights and Measures Handbook and newsletter that covers the subject in significant detail for those interested. Copies are available by contacting George Kleeman, 5104 Alhambra Valley Road, Martinez, CA 94553-9773, e-mail [georgekleeman@comcast.net](mailto:georgekleeman@comcast.net) or it can be downloaded from the USATF website at [www.usatfofficials.com](http://www.usatfofficials.com) under the Training Chair and monographs.

Throws are contested using any one of five rulebooks, High School, NCAA, USATF, IAAF and WMA. In this monograph you can usually consider IAAF, USATF and WMA rules to be identical unless a distinction is pointed out. Note: WMA is the World Masters Athletics which uses the IAAF rulebook with a few additions.

### SAFETY:

By their very nature, throwing events are potentially dangerous events since they involve throwing implements. All officials and athlete in and around these events must be always alert and cognizant of what is happening at the circle. Do not cross runways or the field areas during warm-ups or competition. When in the area, whether in the sector or not, always keep your eye on the runway or the circle. Be prepared for the unexpected. Particular attention must be paid during the warm-up period since the time between throws is much shorter than during competition. Warm-up periods should be under the supervision of an official or coach for all levels of competition. At high school meets, starting in 2005, practice before an event without a coach or official present or practice after an event will result in a warning for the first offense, disqualification from the event for the second offense and disqualification from the meet for the third offense.

Cage recommendations are provided in several rule books for some of the events but they are not full proof. Insist that anyone in the field or at the circle/runway stand so that they can move quickly if necessary in case of an errant throw. Coaches, photographers, spectators and athletes should be kept back at least 10 or more feet away from the sector lines during any throwing competition and more if possible. It is helpful to have flagging that runs parallel

to and about 10-15 feet off the sector lines to insure compliance. If you are in the impact area, position yourself so the implement will land to the side and slightly in front of you. Remember many of the implements tend to skip when they land so never be directly behind them or too close to them on the side. With the hammer remember the wire and be at least 10 feet away from the impact point. Being too close actually makes it harder to see where the discus or javelin lands. Be attentive to the wind direction and whether the thrower is left or right handed since both facts may impact which way the implement will move in the air and after hitting the ground. Don't be bunched up in the field. In a congested field area you might consider using a horn or other noise device to alert nearby athletes and officials that an implement is about to be thrown. Alternately during warm-ups, let five or six implements be thrown and then close the ring or runway and retrieve the implements. Then reopen the ring or runway for warm-ups. Don't let the athletes retrieve their own implements from the sector unless you have no other alternative, and then only by stopping throwing while implements are retrieved. Do not let anyone go into the impact area except the field officials. Return all implements to the area outside of the sector. They should not be thrown back. If you have sufficient officials or volunteers you can return the implement to the circle or runway. Always keep the athletes and ring officials behind the cage or foul line and at least 6 feet back from the netting while waiting to throw. In the case of the shot anyone around the circle should face the circle at all times. No area within 20 feet of the circle is safe particularly with those using the rotation throwing style. Even if they aren't being released, allow warm-ups with implements only in the cage, the circle or on the runway. Cages are now required for hammer, discus and weight events.

Particular attention must be paid to the javelin. Many athletes like to warm-up by throwing the javelin or sticking it out about 10-15 feet. This is fine if it is done on the side in a roped off area but limit the throws to that length. The best way is to make the area only 20-25 feet long. Athletes tend to increase the length of their sticking and thus can impact others if not strictly controlled. All throws longer than about 15 feet should be done only from the runway where people can anticipate them.

Always have anyone going out to the field to get the implements or in the field face the circle or runway. During competition do not call up the next thrower until everyone is ready and any implements have been removed from the impact or jumping area. Make sure the facilities are safe and the areas clear before letting the athlete make an attempt. In the case where cages are used make sure athletes are behind the opening and back several feet from the cage so that they are protected. Be particularly concerned about holes in fencing or netting where an implement might get out. **Stop any event where safety might be compromised either in the event you are conducting or in another event.** The USATF and IAAF now require the throwing landing surface at outdoor meets must be on cinder, grass or a similar substance so that some of the energy will be absorbed. If the throwing event is on a synthetic surface, be it indoors or outdoors, be particularly careful because the energy of the implement is not always absorbed as well as on natural surfaces. In such cases, it may be necessary to have only one event occurring at a time so implements do not impact anyone into an adjoining area.

Once the competition has been started, the competitors should not be permitted to use the circles, runways or areas within the sectors for practice, with or without implements. All the rulebooks except the high schools specifically make that statement. After the event the facilities should closed and not be used for practice during the remainder of the meet because of safety considerations.

#### DEFINITIONS:

Now let's start with some definitions.

A **trial** is an attempt in a field event.

A **flight** is a round of trials for a group of contestants. In high school this can be between 4 and 12 contestants, while in the NCAA it can be between 5 and 12, while in open meets it can be as many as 15 and sometimes more. These are used only in preliminary or qualifying competitions.

A **qualifying competition** is a separate competition in which contestants qualify for the competition proper by either making the qualifying distance or finish high enough after 3 throws to make the competition proper. This procedure normally is used only in championship meets. If an athlete makes the qualifying mark, he is ensured of entry in the competition proper, and so is not eligible to continue in the qualifying competition. Qualifying marks do not carry forward into the competition proper.

A **preliminary competition** consists of three attempts to determine who will be the finalists in the throws.

A **foul throw** is one which is counted as a trial but which is not measured (unless an immediate protest is lodged) because of some violation of the rules.

## **RULES**

### **NUMBER OF TRIALS/CONTESTANTS:**

All throwing events normally have three preliminary rounds when there are 8 or more competitors. The number of finalists normally should be not less than 8 and generally equal to the number of lanes being used around the track. In the preliminary rounds, each competitor is allowed three trials or attempts with the order of competitions determined by lot. In the finals, the finalists throw their final three attempts in reverse order of their best preliminary round marks. In major meets it is acceptable to reverse the order again after 5 rounds for the final throws.

However, in some meets, the Games Committee, particularly non-championship meets, may limit the event to just four attempts for everyone as determined before the start of the competition. In such event this is considered a final. This is important since the NCAA requires an athlete in the final must take their attempts in order when they are scheduled. Thus an excused athlete would miss his turn.

In combined event competitions, competitors only get three trials in throwing events. Ties in such competitions are not broken since it is the points rather than the place that is important. Again the NCAA considers this a final.

In high school competitions, you must have one fair attempt during preliminary rounds to qualify for a final place or the finals no matter how many competitors. In the NCAA you must have one attempt, fair or not to qualify for the finals. If there are more than 8 people in the preliminaries then you take the best 8 throwers to the finals. In high school and NCAA you take those tied for the last qualifying position. In IAAF and USATF you break the tie and take only 8 and true ties to the finals.

### **TIES/PLACES:**

Ties are broken by the next best throw.

In the case of a tie for the last qualifying position for the finals in High School and NCAA meets, you take all ties to the finals. In USATF and IAAF, you break the tie and take only 8 or 9 to the finals depending on the number of lanes being used for finals in straightaway races. Note if an athlete is injured or withdraws but qualifies for the finals that athlete will not be replaced.

If at the end of the event there is a tie for first place (i.e. all 6 throws between the tying competitors were the same), then each tying competitor would get an additional throw until the tie for first place is broken. Ties for other places are not broken by additional competition. In any case, each competitor will be credited with the best of all his or her attempts including trials, which are part of a tie breaking competition. If qualifying rounds are held, qualifying marks to get into the competition do not carry over or are they counted for placement. Generally qualifying rounds only occur at major meets or championships.

### **CALL UP/TIMING/ABSENCES:**

**NOTE: This is a complicated section with each rulebook having exceptions. Consequently it is advisable to read the applicable sections of the current rulebook before each competition to make sure you are applying the proper rules to that competition.**

The Head Event Judge or recorder calls the competitor up to begin his or her trial. This is normally done by saying, ---- is up (about to compete), ----- is on deck (next to compete) and ---- is on hold or at the ready (second in line to compete). You can use their competition number, their first name, or their last name. Many officials prefer to use the last name. Just make sure that they know that they are being called up. The time allowed for a trial starts when the athlete is called up and continues until the start of the motion of the throw. The nominal time for throws is one minute unless they are consecutive attempts. A time foul should not be assessed as long as the attempt is started before the time has elapsed. This is open to some interpretation. But if a thrower is consistent and always does the same motions before starting to throw, namely moves his arms back and forth three times while visualizing his throw, then you should consider him to have started his throw even though he hasn't taken the first step. As part of a proactive officiating posture, it is appropriate for the timer to let an athlete know when he or she is nearing the time limit. An official should indicate to the athlete when there is 15 (USA & IAAF) or 30 seconds (NCAA) remaining by raising a yellow flag and/or by calling out 15 or 30 seconds. The IAAF, NCAA, and USATF require that the yellow flag be raised and held overhead until the throw is completed or the time has run out. The High School rulebook is silent on giving any warning. Generally, you need to give the verbal announcement of the time remaining because most throwers are not facing the sector so that the flag would be seen. It is a matter for the Referee to decide, having all the pertinent information, as to what is an unreasonable delay, but the normal time

guideline should not be exceeded. There is no additional time given to an athlete who has consecutive throws in high school or NCAA events. In USATF, and IAAF throwing events, the increment is doubled. The same time limits are applicable to combined events. (See table below to help clarify the time increments for throwing events). If an athlete has been called up and then passes, or is absent (without being excused), the following athlete is allowed to wait until the passing or absent athlete time expires before he or she can be called up. In IAAF and USATF, if the athlete is excused and is subsequently not present for the trial, you shall assume the athlete is passing once the time for the trial has elapsed. To avoid wasting time and to keep the meet moving, instruct the athletes to pass before they are called up, either when on hold or on deck. If the athlete passes before being called up, then the athlete on deck now is considered up and should be called without significant delay. It may be appropriate for the flight coordinator to say 'so and so' is passing, 'so and so' is up, etc. At the end of a round, preliminary, or finals, when the time for any excused athletes has been completed, the round, preliminary, or event is complete.

**Time in Minutes for Trials**

	<b>Open</b>	<b>Combined Events</b>
	<b>Throws</b>	<b>Throws</b>
<b>NORMALLY</b>		
USATF/IAAF	1	1
NCAA	1	1
HS	1	1
<b>CONSECUTIVE ATTEMPTS</b>		
USATF/IAAF	2	2
NCAA	1	1
HS <sup>1)</sup>	-	-
<b>WARNING</b>		
USATF/IAAF	1/4	1/4
NCAA	1/2	1/2
HS <sup>1)</sup>	-	-

Table Footnotes: *Because these increments continue to be an area for change, please review your rulebook when moving from event to event, or meet to meet, to make sure you are applying the appropriate time increment.*

1) There is no high school rule covering this item.

An athlete may obtain permission to compete in some other event, which will require missing his/her turn or taking it out of order in the rotation. Each rulebook handles this situation differently. In high school sanctioned events, this is alright in both the preliminary and final rounds, assuming the athlete has qualified for the final rounds. The athlete can take his or her attempt out of order, and even in succession. In NCAA meets, an athlete can take preliminary trials out of order and/or in succession, but it must be within the designated flight. The finals should not be delayed because of a missing athlete. Final throws must be in order. In IAAF and USATF, the throws may be out of order for one round at a time in either the preliminary or final rounds if the athlete is excused to compete in another simultaneous event, but may have only one trial per round. In USATF and IAAF, if an athlete is not present for a trial for which he or she was excused, then once the period for the trial has elapsed, it should be assumed that the athlete is passing that attempt. Always attempt to understand where and how long an athlete expects to be gone so you can effectively run your event. Write down the time the athlete leaves and returns. Have the athlete report in and out to the head of the event, or the flight coordinator. You must balance the needs of the excused athlete with those of the other competitors. Currently none of the governing bodies specify a time limit, but the start of the next round or finals should not be delayed for the return of an absent competitor. Most leave it up to the head of the event to manage. Since trials may be taken out of order, make the best accommodation you can so that the impact on the excused athlete and the other athletes is minimized. One way to accomplish this is to let everyone know before the event starts that some athletes are in other events and explain how you plan to accommodate that fact. Remember the guiding principle is a fair competition for all without advantage or disadvantage to any. Make the best accommodation you can, knowing all the circumstances. In big meets, a stricter interpretation is mandatory to keep events on time. Extra time in one event can impact the start time or warm-up period for another event, or it could compromise safety considerations. In international meets and some major national meets, an official must accompany or monitor the athlete if he leaves the venue.

In the NCAA and High School events, athletes must check-in before the first competitive throw to be able to compete. In USATF events, the athlete who is entered but late for the start of the competition can start whenever the athlete arrives, but cannot makeup missed throws, assuming they were entered/declared in the event before the first competitive throw. The IAAF does not offer any recommendations on late athletes. In general, a field event competitor who is entered and has checked in, but is late for the start of the competition, will not be allowed to take missed trials unless previously excused. However, the competitor may take any remaining trials for which the athlete qualifies; i.e., the competitor enters the competition at that point.

A missed throw is considered a time foul unless the athlete has been excused. Remember, it is a matter for the Referee to decide, having all the pertinent information, what is an unreasonable delay. The High School rulebook suggests that the Games Committee should determine the time limit for an excused athlete by taking into consideration the following requirements:

1. The athlete must receive permission to leave from the event judge.
2. The event judge may allow the competitor to take a trial before he leaves.
3. The judge should take into account the length of the race or event for which the competitor is being excused.
4. Record the time excused.
5. If an excused competitor doesn't return by the allotted time, the judge will issue a pass (in NCAA, USATF and IAAF) when his time for the throw is up. High School previously had called for a time foul, although they do call for a pass in the vertical jumps, but they allow out of order and out of round throws in both the preliminary and final sections of an event. The NCAA allows out of round throws only in the preliminary section. USATF and IAAF allow out of order throws in any round.
6. Coaches must take into account the limited time allowed to compete in another event when determining the events in which any individual athlete is entered.
7. The event judge needs to be fair to all competitors, not only the athlete with more than one simultaneous event.

Several of these items are appropriate for consideration in other competitions also. If you are working under an excused time limit, make sure you know what the Games Committee wants you to do if you complete the preliminary rounds, or the event, but the excused time has not yet expired. Normally, I would say you should keep the throwing area open until the end of the time period and then move on with either finals or finalizing the results as appropriate. Typically an athlete is excused for a maximum of 15 minutes. In Youth competitions, when a field event competitor is excused to participate in a running event, a reasonable time limit shall be established by the Games Committee or delegated to the affected Field Event Judge. It is important that the track clerks be aware when they have a field event athlete in a heat so that accommodations can be made. In throwing events, if the competitor returns within the allotted time, and it is during the trial rounds in NCAA or a high school meet, he or she shall be permitted to make up the missed throws or jumps, otherwise such attempts are forfeited. In IAAF and USATF, the athlete must return before the end of the round in which the athlete missed the turn in order to get the missed throw. To compete in the finals in a high school event, an athlete must have a legal preliminary attempt while in the NCAA they must just have an attempt, fair or foul. In USATF, IAAF and NCAA meets, if the event is in the finals and the round in progress has been completed, the competitor shall not be permitted to make up the missed throws. The exception is in high school events where throws can be taken in succession even in the finals to accommodate those who are excused to participate in other events. Throws must be taken before the last thrower complete his or her last throw and either the excuse time is up or the time for the athlete to complete his or her missed throws is up. In NCAA meets the athlete must take his or her final throw when it is his or her turn. They cannot take them out of order, even within the round as they can in USATF or IAAF.

#### COACHING/AID:

Coaching on the field in the event area is allowed in NCAA meets when five or fewer teams are entered in the meet. NCAA teammates can always help one another if they are in the event. In larger meets, NCAA coaches are restricted to the stands or out of the event area much like the USATF and IAAF. NCAA does not have a restriction on crossing the track unless the competition area is defined as inside the track.

In USATF and IAAF meets, coaching or communication using non-technical devices is alright as long as it does not occur in the event area. This means an athlete can get hand signs or go over to the edge of the event area to talk to a coach who is not in the event area and the athlete doesn't leave the event area. An athlete giving or receiving assistance from within the competition area during an event shall be cautioned by the Referee and warned that for any repetition, he/she will be disqualified from that event. Normally athletes leaving the competition area for any reason may need to be accompanied

In High School and USATF Youth meets, the no coaching rule is still in effect. The High School rules have left it up to the Games Committee to define the restricted areas where only competitors and meet officials are allowed. This implies that coaching from an unrestricted area is alright (Rules 3.2.3.q and 4.5.9) which is consistent with the competition/event area concept used by the other jurisdictions.

NCAA, USATF and IAAF forbid the use of electronic devices (video replays, cassette recorders, TVs, radios, CD's and cell phones) in the event area. The event area normally is considered the area in and around the circle and or field, which is open only to the officials for the event and the competitors. The high school rulebook gives that authority to the Games Committee. I recommend that headphones should not be allowed for safety reasons and so competitors can hear when they are called up. Once the competition has begun, the competitors are not permitted to leave that area or to use the throwing circles, runways or area within the sectors for practice trials, with or without implements. Officials may not use cell phones either unless they are being used as meet management tools.

Generally taping of hands or fingers in throwing events is not allowed unless there is an open wound. The exceptions are the hammer and the weight events where individual fingers may be taped with or without gloves. The taping of the wrist is acceptable. There can be no connecting tape device, cast or covering between fingers and palm or back of hand, between the wrist and palm or back of the hand, or between the fingers and the wrist on the throwing hand. Gloves are only allowed in the hammer and weight throwing events in all competitions. The gloves must have the ends of fingers cut off so the fingers show, although the thumb need not be exposed. The exception is in an NCAA meet for the hammer or the weight where an athlete may use a non-adhesive non-elastic single wrap of the fingers which is woven at the base of the fingers in a manner which acts as an open-fingered glove. That means a gauge wrap connected from finger to finger at the base is acceptable. A belt of leather or other suitable material may be worn at the waist by a competitor to protect the spine or back from injury. Braces or elbow protection may be worn as long as they don't give the athlete a mechanical advantage. The sense is that no device that helps an athlete to directly make the throw should be allowed, but protective equipment is OK. The wearing of watches is no longer restricted by any of the rulebooks.

To obtain a better grip in throwing events, competitors may use a suitable substance other than tape on their hands only (chalk or a spray is acceptable). In the shot, they also are allowed to use such materials on their necks (IAAF, USATF, NCAA), but not on the implement itself, the circle, or their shoes. Clearly if the material is on the hands, it will get on the implement. But it may not be applied directly to the implement, except in the NCAA, where chalk may be put on the implements. If it is chalk, it is easily removed if need be. The problem comes from the stickum that often is applied to javelins.

No flags or markers should be placed in the impact area since they could interfere with the mark. No reference marks of any kind can be used in the discus or shot in high school events. For the acceptable location of markers, see the individual event summaries. However, in the discus and javelin, for USATF and IAAF meets, a windsock should appropriately be placed to help the throwers assess the wind conditions.

In the javelin, a competitor in USATF and IAAF meets may place two marks alongside the runway as help. In other competitions, multiple marks may be used, but shoes may not be used in NCAA meets. In high school meets, the Games Committee is charged with defining the number and type of marks that can be used.

Whenever possible you should mark appropriate records or qualifying distances for the competition on the recorder's sheet and along, but outside, the sector lines in the field as a help to the athletes and the officials in the field. It also helps with spectator appeal. Usually, these marks include the stadium record, the meet or league record, the national record, and the world record. In qualifying meets, the automatic qualifying distance or the minimum marking distance may be indicated.

#### **WARM-UP:**

Generally the period for warm-up is set by the games committee. Considerations for setting the warm-up period should include the number of athletes in the competition, the number of flights and the overall time allowed for the event. All rules do not allow use of the ring or runway with or without implements for practice purpose except when schedule. This is as much a safety consideration as anything else but it is also a fairness issue. The NCAA is the only rulebook to define time for warm-up time between preliminary rounds and finals which is a period not greater the time allowed for each flight. This is true even if you have only one flight unless it is determined by the games committee and announced before the start of the competition. Likewise a maximum of 15 minutes should be allowed before each flight. Generally athletes should have a minimum of two throws and generally up to four throw.



A good guideline is allow about 3-4 minutes per athlete for long throws and 2-3 minutes per athlete for short throws. Note what ever time is allowed for one flight should be allowed for any other flight. If you have a general warm-up then cut it off to allow the throwers to have 2 throws before their flight. Use the same time as in warm-up for flights when you go to finals, if there are athletes from several flights in the finals. If you are time constrained give just athletes not in the last flight to qualify the two throws. If you are going to do this announce it before the warm-up for the first flight begins. Using these rules of thumb you can calculate how long each flight will take and the overall time.

Event	Time for Warm-up Per Throw	Time for Competition per Throw
Weight & Shot	30 sec	45 sec
Javelin, Discus, Hammer	45 sec	60 sec

### **FACILITIES:**

#### **CIRCLES/RUNWAYS:**

All five of the throwing events start from a circle since the toe board in the javelin is also an arc or a circle. The discus, shot, hammer and weight are thrown from a circular ring that is bounded by a 1/4 inch iron or steel band, the top of which is sunk flush with the ground outside the ring and the landing area. The surface of the circle/ring is firm and level and normally concrete, although that is not mandatory. The surface is 2 cm, plus or minus 6 mm lower than the upper edge of the rim. The inside diameter of the shot, hammer and weight circles are 2.135 meters (7 ft) in diameter, and for the discus it is 2.5 meters (8 feet 2 1/2 inches). The rim should be painted white and marked clearly to divide it into the front and back half. The back of the line dividing the front and back halves of the circle should be even with the center of the circle, since touching any part of the line is a foul. Portable rings meeting the specifications are acceptable, but make sure they don't rock or flex. The javelin is thrown from a runway, which is terminated by arc of a circle, 8 meters (26 feet 3 inches) in diameter. The toe board is 7 cm wide and can be made of wood or painted white, or a white line of similar width on a synthetic surface. The runway for the javelin should be 4 meters wide inside the foul lines, and between 30 meters (98 feet 6 inches) and 36.5 meters (120 feet) in length. Note metal toe boards are no longer used except in high school because of safety concerns.

#### **SET UP: (Sectors and Cage Opening)**

Starting in 2007 there are just two throwing sectors, 28.95 and 34.92, degrees. The first is for the javelin and the second for the discus, hammer, weight and shot. Each are relatively simple to layout. For the javelin you measure from the center of the circle which forms the arc and for every 10 meters out from the center the distance between inside of the sector lines is 5 meters or half the distance out. For the 34.92 degree section it is 6 meters between the inside of the sector lines at 10 meters or 0.6 times the distance from the center of the throwing circle. Note the distance lines are measured from the inside edge of the circle and must be done separately..

Event	USATF/IAAF/ NCAA/HS	Formula
Shot	34.92°	b=0.6a
Discus	34.92°	b=0.6a
Hammer/Weight	34.92°	b=0.6a
Javelin	28.95°	b=0.5a or a/2

where a = distance from the center of the circle on the sector line, b= distance between the inside edge of the sector line. For sector layout and the dimensions for each sector, see Appendix B.

The surface of the sector may consist of cinders, grass, or other suitable substance on which the implement will leave a clear mark. Synthetic surfaces are not allowed in USATF because they tend not to absorb the energy of the implement and allow it to skip further.

All cages are different. Cage specifications and setting are **recommendations only** and are based on safety. The cage opening for the discus throw should be such that it is equivalent to 6 meters for USATF and IAAF meets at a point 7 meters out from the center of the circle, and 8 to 9 meters for the NCAA at 4.2 meters from the center of the throwing circle, respectively. For the hammer, with the existing NCAA cages, the recommendation for USATF and IAAF meets is to set the outer edge of the open door about 1.1 m off the sector line, and the end of the closed door perpendicular to the sector line or 1.5 m inside the sector line. For the NCAA competition, set the closed gate at 1.5 m inside the sector line or perpendicular if not long enough and the open gate so it is 2.85 meters off the line at the end. In the discus, if the cage is equipped with moveable gates, they should be set at equal distance from the

sector lines for the discus as indicated above, and changed for the hammer and weight throw depending on whether the thrower is left or right handed. The moveable gate makes the opening smaller for the hammer. This is to protect the spectators, officials and competitors by restricting errant throws out to about 180 feet. When the panels are in place for a right handed thrower, the panel on the left side, as you face the impact area, should extend inside the sector line up to about 1.5 meters, and be perpendicular to the sector line, if possible for all competitions. The opposite should be the case for the left-handed throwers. To help keep the competition moving, you need to assign several of the officials working around the cage to move the gates when needed. Note - it is also useful to clearly mark the location of both gates before the competition. In setting the gates for the hammer, there is always some trial and error. The important thing is safety. If you need to narrow it further, then do so. If you do, you may need to make an accommodation for those throwers that hit the open gate. Note hitting the closed gate means their throw would have been out of the sector and thus is not grounds for a replacement throw. All dimensions are approximate and should be conformed with to the extent possible, but if safety requires a slightly smaller opening, then set the gates closer. The minimum recommended height for the discus cage is 4 m but at least 5 is necessary. For the hammer the back of the cage should be at least 5 m and the front panels and gates at least 6.15 m. The international cage is now 7 m in the back and 10 m in the front. The high school discus cage is slightly squarer with a 20 to 24 feet opening and being 20 to 21 feet 6 inches deep. The center of the circle is 10 to 10 feet 6 inches back from the end of the cage. It is typically 10 to 14 feet high. The fencing should be made of an energy absorbing material, usually loosely hung netting. Chain link fences may protect the crowd but allow the implement to rebound back on the athlete.

The legal shot stop board is 1.22 m (4 feet) long, measured along the inside circumference. This is equivalent to a chord length between the inside edge corners of 1.15 m (+/- 1 cm) if the ends are radii. The width spec varies slightly with different rule books but is 112-116 mm (4 1/2 inches) wide at its narrowest point and 300 mm at its widest and 98-102 mm (4 inches) high. If the ends are parallel to the sides of the circle, then the chord length will be 1.22 m. Either type is acceptable.

#### USE OF FLAGS:

There are three flags normally used in a throwing event - white for a fair throw, red for a foul, and yellow to indicate a time warning. The yellow flag is raised with 15 seconds remaining on the time clock in IAAF and USATF meets, and with 30 seconds remaining in NCAA meets, and kept up until the throw has been initiated or the time has run out. There is no such rule for high school meets. Flags generally are used in preference to verbal commands. In fact, try not to yell "Fair" or "Foul". If you must say something, say "Mark" or "No Mark", although these words are optional in all except in high school events. Flags also are used to communicate with the field officials in the longer throws since often they can't hear comments at the circle. Once a competitor has completed an attempt, including leaving the throwing area, and the implement has landed in the field, the head judge will indicate a legal attempt by raising the white flag straight over his head so everyone can see it. One set of flags at the circle and one in the field are normally adequate, although some people have used a flag for the ring judges on both sides of the circle. In other areas, the other ring officials merely indicate a fair or foul attempt with a thumb up or thumb down signal to the official with the flags. If it is an illegal attempt, the judge will raise the red flag. Do not wave it around. Do not yell "Mark" or raise your flag until the athlete has completed the attempt and left the runway or circle. (A high school rule still requires the Judge to call "Mark" as soon as the implement lands and the athlete must remain in the circle or on the runway until the call is made.) Keep the flags for signaling a fair or foul throw up until the field crew acknowledges it. This may take a few moments since the field crew is busy with getting the mark and probably won't look up until that is done. Also, use a red flag in the field to indicate that the field crew is not ready for the next attempt or that the throw is out of the sector. The white can be used to indicate that the field crew is ready, particularly at the start of the competition or after an interruption. Make sure there is enough time for the implement to be safely removed from the impact area before the next thrower is called up.

#### COMPETITION/THROWING FORM REQUIREMENTS:

Watch for the initiation of the throw. The competitor may enter the circle or runway any way they want. They must start from a stationary position in the circle or on the runway and end by leaving the circle from the back half or behind the arc after the implement has hit in the field. It is no longer necessary that the athlete also leave under control if the competitor has met the other criteria, except in high school. Watch that the throw conforms to the form requirements in the shot, hammer, weight and javelin. Note - there are no form requirements for the discus. Watch for foot fouls. One ring official should watch the flight of the implement to know when it has landed, and the other should continue to watch the competitor to make sure he remains in the circle or on the runway until the implement has landed.

#### JAVELIN THROWING REQUIREMENTS:

The javelin must be held at the grip with one hand only, with the little finger nearest to the point and thrown over the shoulder or upper part of the arm and not slung, hurled or thrown side-armed. The thrower's last contact with the javelin is with the grip. Non-orthodox styles are not permitted. During the run-up and until the javelin is released, a competitor may not turn completely around while in the act of throwing so that his back is toward the throwing arc. This is to prevent someone from using a rotational throwing style, which would be a safety concern. It is a foul if any part of the body touches any of the lines marking the boundaries of the throwing area or the ground outside before the javelin is released.

#### PUTTING REQUIREMENTS:

The shot must be put from the shoulder with one hand only. It is not a throw. That means the shot shall touch or be in close proximity to the chin and at no time may the shot drop below this point or behind the line of the shoulders. That is, no baseball throws. Not only is it illegal, it can be very damaging to the elbow. Note the rulebooks do not require that the ball be released between the neck and the outside of the shoulder.

#### HAMMER & WEIGHT THROWING REQUIREMENTS:

The hammer and weight must be thrown with both hands in USATF and WMA on the grip or handle. One hand throwing of the hammer or weight is not allowed unless there is a handicap. The NCAA and IAAF do not have that requirement although I have never seen these implements thrown with one hand except in the Highland Games. Otherwise there are no other form rules. After starting the rotation of the implement, it is no longer a foul if the implement hits the ground inside or outside of the circle during the spin, even if the athlete stops and restarts the throw.

#### DISCUS THROWING REQUIREMENTS:

There are no form rules other than starting from a stationary position in the circle. Any method is currently acceptable as long as it is safe.

#### MEASUREMENT:

The method of measurements of throws has changed several times since 1998. The hardest implement to mark is the discus, now that the javelin has been changed so that it normally lands point first. But the javelin remains the second hardest, particularly for high school, Masters, and Youth. The lighter javelins are less aerodynamic, and thus, they are more prone to landing flat (handle first) or tail first if not thrown properly. Details of how to mark are given later in the step by step directions. In general, throw measurements are done metrically to the nearest shorter centimeter or imperically to the nearest shorter 1/4 inch, or nearest shorter whole inch, depending on the implement and under which rulebook the meet is being conducted. In the high school and junior college meets, the shot put is measured to the nearer shorter 1/4 inch or centimeter, while the longer throws - the discus, the hammer and the javelin - are measured to the nearest shorter inch or even centimeter. Since 2002, in NCAA, IAAF and USATF meets, all throws are measured to the nearest lower centimeter. The tape zero should be at the beginning of the mark in the field closest to the circle. The measurement is from the inside of the circle or arc on a line through the center of the circle to the point of impact closest to the circle. Measurements should be made immediately following each throw. Each fair throw should be measured unless otherwise instructed by meet management, e.g., less than a qualifying distance set for measurement. Usually a fiberglass tape is used, although some shot put officials prefer a steel tape. A certified steel tape or electronic measurement is required for records in USATF, IAAF and NCAA competitions but is not required for high school records. Because fiberglass tapes tend to stretch, it is always advisable in the case of a record to verify the distance with a steel tape. A procedure for calibration and certification of electronic measuring equipment is available as part of the Electronic Measuring Official's Manual.

Governing	Imperial	Metric	Implements
High School	Yes (1/4") Preferred	1 cm	Shot
	Yes (1") Preferred	Even Cm	Discus, Javelin, Hammer
Cal. Jr. College	Yes (1/4") Preferred	1 cm	Shot, Weight
	Yes (1") Preferred	1 cm	Discus, Javelin, Hammer
NCAA	Yes (1/4")	Yes (Preferred) (1 cm)	Shot, Weight
	Yes (1")	Yes (Preferred) (1 cm)	Discus, Javelin, Hammer
USATF/IAAF/WMA	No	Yes (1 cm)	All

#### FOULS:

#### **All Throws**

1. It is a foul if the competitor does not leave from the back half of the circle or behind the arc after the implement has hit the ground. The first step is all that is required to be behind the line or arc, or the lines drawn from the extremities of the arc. In high school, the competitor must leave under control and after the official has indicated that the throw will be marked by saying, "Mark".
2. It is a foul if the competitor exceeds the normal time limit before the start of the attempt.
3. It is a foul if the implement thrown in warm-up period or competition does not conform to the required specifications.
4. It is a foul if improper taping or a glove is used on the hand other than in the hammer or weight throw. To improve your grip you can put any suitable substance on your hands only such as chalk or an adhesive type substance. Only the NCAA allows chalk to be applied directly to implements. For the hammer and weight you can apply the suitable substance to the glove. In the shot you also can apply chalk to your neck in NCAA, USATF and IAAF. It is a foul to put a substance or chalk on your shoes or on the surface of circle or runway in NCAA, USATF or IAAF competitions. Note the substance can be transferred from your hand to the implement but not put on the implement directly.
5. It is a foul if the implement (i.e., the ball versus the handle or wire of the hammer or weight, the discus or point of the javelin [or first mark of the javelin for high school and youth]) does not land completely in the sector (i.e. the visible mark may not touch the sector line). The javelin shaft, the connection or the grip of the hammer or weight, does not have to be in the sector.
6. It is a foul to drop the implement outside the circle but inside of the cage area while in the circle.
7. It is a foul to put any substance on your shoes or in the circle, NCAA, USATF, IAAF.

### **From a Circle**

1. It is a foul if the competitor touches the top of the circle or the stopboard, or the ground outside the circle with any part of his body. But a thrower is allowed to touch the inside of the iron band or the back of the shot toe board. Likewise, a thrower can stop an attempt provided he has not otherwise fouled, and restart his trial from a stationary position, or lay down the implement, inside or outside the circle and then leave the circle from the back half under control. He can then re-enter and start his throw again from a stationary position. The time clock continues to run except in the most extraordinary circumstances when the chief judge awards a new attempt. (See item 5 below.)
2. It is a foul if the competitor does not become stationary in the circle before starting the throw.
3. It is a foul if the athlete leaves the circle or runway before the implement lands.
4. It is a foul if the athlete does not leave the circle by the back half, or does not leave the runway behind the perpendicular lines marking the ends of the arc.

### **It is not a foul if:**

1. Part of the body or foot swings outside the ring but does not touch.
2. A shoelace or a pant leg touches the top of the ring or beyond the foul board.
3. The implement hits the cage, as long as the implement lands in the sector. It is considered a fair throw except in high school discus where it is a foul (6-3-9.d)
4. The hammer, javelin or weight breaks anytime during a throw. A new attempt will be awarded, even if the competitor shall foul as a result of the implement breaking.
5. The hammer or weight hits the ring inside or outside once the motion has started, even if the throw is stopped.
6. Sunglasses or a hat fall off and out of the circle or runway.

### **Individual Events**

1. It is a foul if you do not conform to the legal definition of a put or javelin throw. For the discus, hammer or weight throw, there are no specified form rules that must be used. (See earlier section on form requirements for more detail.)
2. In high school meets only, it is a foul if the discus hits the cage. In other meets, as long as the discus lands in the sector, it is considered a fair throw.
3. At the start of the hammer or the weight throw, the head can be laid down inside or outside of the circle. Once the motion is started, it is a fair throw even if the hammer or weight hits the ring inside or outside as long as no other infringement of the rules has occurred.
4. It is not a foul if the hammer, weight or javelin breaks anytime during a throw. A new attempt will be awarded even if the competitor shall foul as a result of the break.
5. It is a foul in the javelin if, on the run up, the competitor steps on or over the lines marking the side or foul lines on the runway.
6. The rules for a weight competition are the same as those for the hammer.

### **DISQUALIFICATION:**

Remember - only a referee is empowered to disqualify someone from a competition. This is sometimes delegated, particularly if there is only one referee or the throwing site is away from the rest of the events. But it is better to call the referee if you have a problem and let the referee do the disqualification. Marks up to the disqualification stand in high school and NCAA, and if in another session for USATF and IAAF. Starting in 2006 for USATF and IAAF, if an athlete is disqualified, then all marks during that session are nullified (Rule 145). In giving a formal warning the referee should show the offending athlete a yellow card and if disqualifying the athlete, a red card.

APPLICABLE MAJOR RULE REFERENCES:

	<b>SHOT</b>	<b>DISCUS</b>
IAAF	180,187,188, 221	180,187,189, 190
USA(OPEN, MASTERS)	180, 187,188, 221	180, 187, 189,190,
(MASTERS) WEIGHTS	332.3	332.3
(YOUTH) WEIGHTS	301	301
WMA	14, App. A-3	15, App. A 4
NCAA	1.7, 1.8, 2.8, 6.1-6.4, 6.8, 10.6, 10.7	1.7, 1.9, 2.9, 6.1-6.4, 6.9
HIGH SCHOOL	2.2,6.1,6.2,6.3, 6.5	2.2,6.1-6.4
	<b>JAVELIN</b>	<b>HAMMER</b>
IAAF	180, 187, 193	180, 187,191-192
USA(OPEN, MASTERS)	180, 187, 193	180, 187 190-191
(MASTERS) WEIGHTS	332.3	332.3
(YOUTH) WEIGHTS	301	301
WMA	17, App. A 5	16, App. A-6
NCAA	1.12, 2.11, 6.1-6.4, 6.10	1.7, 1.10, 2.10, 6.1-6.4, 6.11
HIGH SCHOOL	2.2, 6.1, 6.2, 6.6	8.2.1
	<b>WEIGHT</b>	
USA(OPEN, MASTERS)	180, 187, 190, 191, 195, 201,	
	202,221	
(MASTERS) WEIGHTS	332.3	
WMA	18, App. A-7	
NCAA	1.7, 1.11, 6.1-6.4, 6.11, 10.8, 10.9	

NOTE: There are other applicable sections that you should know, although most of the information is covered above. Be familiar with each of the rulebooks. Each is organized differently.

## **OFFICIALS:**

### **PROACTIVE OFFICIATING/PROBLEM SOLVING AND AVOIDANCE:**

One of the best ways to have a good meet is to eliminate problems before they occur by being proactive. You are there to ensure a fair and safe competition by compliance with the rules, not to disqualify athletes. The following are recommendations for all meets and all officials.

1. Start on time. This gives all of the athletes, coaches and other participant's confidence that the meet will be run properly.
2. Make crisp, clear and decisive decisions. Confusion is the fastest way to get people unhappy. Only one person is likely to be unhappy when a decision is made. When there is confusion and decisions are changed or not made, there will always be more than one person unhappy.
3. Know the rules.
4. Know the system. Know how to direct people to others for answers. Do not try to do someone else's job. If only the referee can make a decision, then pass the problem along to the referee and do not decide or give an opinion.
5. If you're the head official, monitor the help. Make sure they know what they are doing and are doing a proper job by occasionally checking on their judging, times or measurements.

### **GENERAL:**

As an official, you should always:

- a) observe the Officials Code of Ethics,
- b) be aware of and come in the uniform of the day; i.e., you should not stand out. You're not the show, the athletes are.
- c) come prepared; know your assignment,
- d) look sharp while in the field, and if you march in and out, do it with style,
- e) be alert at all times; throwing events are particularly dangerous events,
- f) don't congregate together, but instead go to your assigned position and remain alert,
- g) always treat every meet as if it were the most important meet.
- h) treat athletes, other officials, and coaches with consideration and tact.

### **NUMBER OF OFFICIALS:**

Because we often do not have sufficient field officials at meets, we end up officiating with minimum crew except in the biggest meets. Consequently, the following tables were put together to indicate which are considered the most critical positions in each of the throwing events, and where to distribute your limited officials. The Minimum case includes just the number required to do the event safely. The Normal case includes the routine crew size to be expected in most meets. The Major Event case is the full crew used in major championships and is the maximum case. Positions shown are as you face the sector. These are my preferences. You may have others. The choice is yours. But cover the most critical position in your opinion, i.e. the hardest position or the one that has the most problems or fouls.

EVENT	CRITICAL POSITION	WATCH
Shot	Right Circle <sup>1)</sup>	Form
Hammer	Right Circle <sup>1)</sup>	Feet
Javelin	Marker	Landing
Weight	Right Circle <sup>1)</sup>	Feet
Discus	Marker	Landing

1) This assumes that most throwers are right-handed. If you have left-handed throwers then the opposite side is appropriate.

These can and should be modified for the conditions. This is particularly true if it is extremely hot or cold, or if you are using electronic measuring equipment or scoreboards. Where fractions are shown, these can be shared jobs, i.e. 1/3 is one of three jobs for the individual. If you are using an electronic recording device like FieldLynx then that person can act as the second recorder. It is important to have at least one written recording sheet.

SHOT	MINIMUM	NORMAL	MAJOR EVENT
HEAD	1/4	1/2	1
RECORDER	1/4	1/2	1/2

/COORDINATOR			
TAPE PULLER	1/4	1/2	1
CIRCLE/TAPE READER	1/4	1/2	1/2
FIELD TAPE	1/3	1/2	1
MARKER	1/3	1/2	2
RETRIEVER/SECTOR	1/3	1	2
FIELDLYNX	-	-	2
TOTAL	2	4	10

<b>DISCUS</b>	MINIMUM	NORMAL	MAJOR EVENT
HEAD	-	1/2	1
RECORDER /COORDINATOR	1/2	1/2	1
TAPE PULLER	1/2	1/2	1
CIRCLE/TAPE READER	1	1	1
FIELD TAPE	1/2	1	1
MARKER	1	1 1/2	2
RETRIEVER/SECTOR	1/2	1/2	2
FIELDLYNX	-	1/2	2
TOTAL	4	6	11

<b>JAVELIN</b>	MINIMUM	NORMAL	MAJOR EVENT
HEAD	1/2	1	1
RECORDER /COORDINATOR	1/2	1/2	1
TAPE PULLER	1/2	1/2	1
ARC/TAPE READER	1/2	1/2	1
FIELD TAPE	1/2	1/2	1
MARKER	1 1/2	1 1/2	2
POINT/FLAT	1/2	1	1
RETRIEVER/SECTOR	1/2	1	2
FIELDLYNX/BOARD	-	1/2	2
TOTAL	5	7	12

<b>HAMMER(WEIGHT)</b>	MINIMUM	NORMAL	MAJOR EVENT
HEAD	1/2	1/2	1
DOORS	1/3	1/2	1/2
RECORDER /COORDINATOR	1/3	1/2	1/2
TAPE PULLER	1/2	1/2	1
CIRCLE/TAPE READER	1/3	1/2	1
FIELD TAPE	1/2	1/2	1
MARKER	1	1 1/2	2
RETRIEVER/SECTOR	1/2	1	2
FIELDLYNX	-	1/2	2
TOTAL	4	6	11

Generally the numbers would remain essentially the same for the minimum and normal cases even if you used electronic measuring since the tape puller and field tape positions are taken by the electronic measurement official and the reflector official. However, could be reduced by one in the maximum or championship case.

To these you can add other things at major meets like sign board operators, communicators for the announcers., a weights and measures person, LaserLynx operator (replacing the tape puller at the circle) etc. Others might call for a minimum of three officials for the shot and four for the other events. I would assign the next official as a retriever in order to speed up the event and keep the athletes out of the sector.

The suggested location for each of the officials is (also see Appendix B for a drawing of each venue):

Head of Event: Normally as a third circle official and second reader and recorder, as well as timer for the event. Usually the head is on one side or the other, but generally the same side as the athlete bench which usually is the left side as you face the impact area.

Recorder: At the right side of the competition area as you face the impact area, since most tapes are read from the left side. This official would normally be the one with the FieldLynx™ Palm Pilot™.

Tape Puller: To the side the tape is on, usually the right side of the competition area so it is out of the way for implement return and the reader.

Circle: Either side of the circle or runway so can cover both the back and front of the circle on one side. Move forward as the thrower does. One of the two needs to watch for landing and call whether the athlete leaves before the implement lands, and the other continue to watch the thrower to make sure he doesn't foul before the implement hits and the thrower leaves the circle or runway.

Tape Reader: Normally would be official on the left side so that the tape numbers are facing him and he is facing the recorder.

Flight Coordinator: Located with the athlete bench area.

Field Tape: On the right sector line out about as far as the throw is expected, or in the center of the field to minimize the time to get to the mark. Can also serve as sector line judge and alternate spotter.

Marker: At the side of the impact area, but slightly behind and to the side of where implement is expected to hit, so can move quickly up to and even with it for the best marking.

Retriever: Used to carry implements out of the impact area. If enough, would return to throwing area. Can be used as a sector line official or an alternate marker. Located near the expected impact area, often on the sector line. Usually located on the opposite side as the tape man to avoid having to cross the tape to retrieve the implements. Usually on the side where the athlete bench is located.

Point/Flat: Used to make the determination if the javelin lands point first or not. Can also act as a retriever. Situated outside of the sector line a few yards near the expected impact area. Should be low and be able to clearly see the landing.

Distance Boardman: Converts metric recorded reading to Imperial distance and posts result on the performance board. Normally located on one side of the throwing area depending on where the crowd is located. In the case of electronic signboards, you can you can eliminate this job and cover it with the recorder.

#### DUTIES:

Head Event Judge: a) Before the start of competition: conduct pre-event review session with officials and athletes, supervise all warm-up activities, inspect hands for illegal taping, and communicate instructions to athletes. b) After the start of competition: coordinate all ring judges, raise white or red flag after each attempt, observe foot faults in ring and any other infractions that may personally be observed and will watch for throws out of the sector. Operates the left gate on the hammer cage. Places a cone in ring or on the runway after each attempt. Reads the measurement and removes the cone as the next contestant is called. In some cases will also act as the first recorder and liaison with Field Referee. When there are enough officials, the head should act as an overviewer for the whole event and limit his or her other roles. Normally located around the front of the circle on the side with the athlete, which is usually the left side as you face the impact area.

Ring Judge: a) Before the start of competition: Sweep the circle when needed, keep towels in back of ring for cleaning hands or feet. b) After the start of competition: Observe foot faults in ring, and moves forward as needed. One watches thrower in ring until competitor leaves. One needs to watch the landing to make sure the implement has landed before the thrower leaves the circle. Moves forward as the thrower does. May act as second recorder. Operates the right gate on the hammer cage. Sweeps the ring with broom when necessary. Total needed: at least two and as many as four. Located on either side of the circle and in front and back.

Implement Inspector: a) Before the start of competition: Responsible for obtaining implements from Weights and Measures area, check that each has cleared, making sure they get to the throwing area, keep implements neatly arranged on rack, cleans and inspects each implement as it is returned from the field during warm-ups, ensure the athletes use only meet approved implements and do not alter implements in any manner. This is particularly important for the hammer on a muddy day. b) After the start of competition: Keep implements neatly arranged on rack. Cleans and inspects each implement as it is returned from the field, ensures that athletes use only meet implements and do not alter them in any manner. In a qualifying competition, the inspector will impound qualifying



implements and return them to the Weights and Measures area. In some cases all implements are returned to the Weights & Measures area where the competitors can pick them up.

Flight Coordinator: a) Before the start of competition: Coordinates athletes warm-up and informs competitors of throwing order, number of practice throws, organizes athlete introductions, and posts copy of the throwing order for competitors to view. b) After the start of competition: Calls the competitors up, on deck, and on hold, maintains the order and timing of competition, coordinates the removal of the cone from the circle and start of the clock as the competitor is called. Usually used only in major meets to unload the event head, who has to deal with TV, the press, and other persons not normally on the field of play.

Timer: Position clock in view of operator and competitor. Starts clock when the competitor is called. (Cone is removed at the same time.) Signals to the Head Judge if the time expires before the competitor initiates the attempt.

Tape Reader: Normally would be official on the left side so that the tape numbers are facing him and he is facing the recorder. One of the recorders or one of the ring judges normally does this job.

First Recorder: After the competition begins, should record numbers on performance sheet or computer as read by the head judge for each performance. Numbers should be repeated aloud by the recorder as a check that they were read and recorded correctly. This role often is combined with the flight coordinator. Located on the right side of the competition area as you face the impact area, since most tapes are read from the left side.

Second Recorder: This role is the same as the first recorder but the readings are not read out loud. After each round, verifies performance and qualifiers with first recorder. It is sometimes combined with the performance board operator role. Can be anywhere around circle depending on other assigned duties. Check recorded distances after each round with the First Recorder.

Tape Puller at Ring/Laser Operator: a) Before the start of competition: Help with retrieving. b) After the start of competition: Picks up the tape as the tape puller enters the cage in order to begin to pull or feed out tape while walking around to the back of the circle (not through the circle) and pulls the tape through the mark at the center of the circle. Being behind and not in the circle is particularly important when the area around the circle is wet, dirt or fresh cut grass. Be sure the tape is straight from the point of impact through the center of the ring by pulling the tape tight and then releasing most of the tension but keeping on some pressure to get the correct measurement. Normally this individual is also an extra ring judge and watches for ring infractions and reports any infraction to the Head Judge. Location is to the side of the circle that the tape is on, usually the right side of the competition area so it is out of the way for implement return and the reader. Alternately this may be a laser operator

Tape Puller in Field/Reflector Official: a) Before the start of competition: Stand at "parade rest" in position. Help the retrievers and keep all the athletes and press away from the sector. b) After the start of competition: Move the tape to the mark for each fair throw, holding the zero mark at the first point of contact of the implement that is closest to the scratch line. Act as back up to markers in case they loose the mark when moving toward it. Hold the position at the mark until the Recorder indicates the measurement is completed. Moves the tape to the side of the sector after each throw to minimize the possibility of it being hit by the throw or damage to the tape. Located on the right sector line or in the center of the field about out as far as the throw is expected. Can also serve as sector line judge if staged there. Alternately, if using a laser measuring device this person will hold the reflector in the field.

Sector Judge: a) Act as retriever before the start of competition. b) During the competition, determine sector fouls. Normally combined with other jobs such as Tape Puller in field, Retriever, or possibly Marker.

Landing Judge/Marker: a) Before the start of competition, stand at "parade rest" in position, helping the retrievers and keep athletes and others out of the landing area. b) After the start of competition, marks the first point of contact of the implement in the landing area. Located at one side of the impact area on the opposite where the implements are being returned, but slightly behind and to the side of where implement is expected to hit, so can move quickly into the mark for the best marking. Marks each attempt and holds the position until the mark is recorded or the next competitor is called up. May assist in determining sector foul landings. May at times also serve as a retriever. Need: at least one, and for hammer two or three, depending on level of competition. In many competitions, will also have to act as sector line judge since near the sector line while waiting for the implement to be marked.

Implement Retriever: During warm-up and competition, stands at "parade rest" at side of sector at about the area where throw is expected to land until needed to retrieve the implement out of the impact area and return it to the Implement Inspector. May also act to retrieve implement from the sector during warm-up periods. Can be used as a sector line official or an alternate marker. Need: at least one and normally two or three depending on level of competition and heat of day. Normally located on the side opposite to the tape puller/ reflector official so they don't have to jump the tape while retrieving implements.

Javelin Landing Official: a) Before the competition, helps as a retriever. b) During competition, is positioned outside the sector at approximately the expected distance for the throw of each individual and checks to make sure the tip is the first part to hit the ground. May need to be down on one knee to properly see the landing. This person should not normally also try to be a marker unless there are insufficient officials.

Performance Board Operator: a) Before competition, help as a retriever. b) During competition, post performances on board in either Imperial or Metric measurement as dictated by Meet Management. May need to convert from Metric to Imperial distance. May be combined with the Field Communicator. Needed: normally one for each board. Normally located on one side of the throwing area depending on where the crowd is located.

Escort/Steward: a) During the warm-up period may help as retriever. b) When needed, will accompany athlete to see coaches, rest room, or back to clerking area. At major events an official must accompany athletes at all times. Needed: Normally at least one for every 5-8 athletes.

Marshal: This job often is done by other officials or by security personnel. The job is to maintain order in and around the sector and make sure all people along sidelines are standing and facing the circle if they are within the implement landing area. Needed: Normally at least two, and more if photographers don't have an assigned area.

Field Communicator: Communicate with announcer pertinent information on throws and passes, and athlete control.

### Marching Order

This order will vary somewhat depending on number of officials and their assignments. The head official should lead the group out. The remaining officials normally follow in rows of two. The field assigned officials should be first so that they can continue into the field when they arrive at the venue. The circle officials should follow. Those on one side should be behind each other so that they can conveniently split at the circle.

## **STEP BY STEP GUIDE FOR FIELD OFFICIALS ON THE DAY OF THE COMPETITION**

This section deals with the order of activities for a field official each time he or she is scheduled to work a competition. The differences between the rules of the various sanctioning bodies are highlighted. It repeats much of what has been discussed in previous sections but presents it in a time sequence versus a subject matter format.

### BEFORE COMPETITION:

1. Read the applicable rules for your event in the current rulebook the night before the competition. Remember the words "must" and "shall" mean it is compulsory, while "should" means it is hoped the rule will be followed but it is not mandatory.
2. Arrive early, at least 30 minutes before warm-up for your event is scheduled to start. If possible, 45 minutes or more is recommended, particularly if this is your first time at the venue or working with this meet director or field referee. In a big meet, you will probably need to be there more than an hour before the event, particularly if you are the head official. The warm-up period may be divided into general warm-up and flight warm-up if you have more than one flight. The NCAA recommends about 15 minutes for each flight warm-up.
3. If you are the chief judge, check in first with the Head Field Judge or Field Referee to see if there are any special rules or notes for the day, like a decision by the Games Committee to have only 4 throws, not to have flights, or a special warm-up time. If you are the head event judge, pick up the event sheet and equipment.
4. Check out the facilities:
  - a. Check the circle or runway to see if it is clean, dry and in good repair.
  - b. For the shot, check the toe board to make sure it is tightly held in the concrete. For the hammer, if it is a dual discus/hammer facility, check that the ring insert is properly installed and shimmed, if necessary.
  - c. Check the cage opening and position of movable gates for the discus and hammer. For USATF and IAAF, it is 6 meters at 7 meters out from the center of the circle. For high school and NCAA, it is 8-9 meters at 4.2 meters out from the center of the circle. The opening is centered for discus, and moves right or left of the thrower depending on whether the thrower is left- or right-handed in the hammer. Check the condition of the cage; i.e., the netting and the operation of the doors. Are there any openings in the net where an implement might escape? Make sure the netting is loose so it will absorb the energy of the throw rather than rebound the implement back at the thrower.
  - d. Check the layout of the sector or runway to make sure the lines are correctly placed. Measure out any distance lines, so you can let the athletes know their distances. If it is not laid out properly, do it yourself. Hammer, discus, and shot sectors are now all 34.92 degrees so pick any distance out and see if the distance between the line is 0.6 times the distance from the center of the circle. It helps if you have three people and three tapes so one person hold the zero ends of the tapes at the center of the circle and the two in the field walk out the sector line to the measuring point and they hold the third tape between them. The javelin sector is 28.95 degrees for all rulebooks which means the distance between the sector lines at any point is equal to half the distance out. For the javelin this is easily checked by taking a tape to the first distance line and comparing the distance between the sector line to the metric distance to the line plus 8 meters divided by 2.
  - e. Check the sector, runway, and normal walking areas for any tripping hazards or standing water. Remove any markers left on the runways or in the sector from previous competitions or practice. Check outside the sector

for possible interference with other events. IAAF and USATF now require a windsock to be positioned near the throwing area for the discus and javelin.

- f. Check to make sure you have needed rakes, brooms, tapes, markers, forms, pens, flags, watch, ladders, sector markers, distance markers, performance indicators, windsocks, record indicators, recorder stand.
5. Check with the Weight and Measurements officials to see what color or marking will be used on implements today and when they will be delivered or if the athletes will bring their own. Find out if any have failed.
6. Erect barriers to keep everyone but those who are officiating the field event off of the runway or landing area. Include a safety buffer on either side of at least 10 to 15 feet. Get any additional help or marshals you need to ensure the safe conduct of your event; i.e., safety for athletes, officials, coaches and spectators both within the competition area and/or adjacent to it is paramount. Implements have been known to affect all field events and many track events depending on the location of the venue. Note the impact area for the discus is some 69 degree assuming the athlete doesn't throw it over the side of the cage. For the hammer it is slightly less at 53 degrees because of the higher sides and doors. Thus the impact area increases considerably the further out in the field. Note the shot without a cage has a 360 degree danger zone although most is in the front 70 degrees or so. The impact zone is variable because of wind conditions particularly for the discus and javelin.
7. Have athletes check in with the head event official or flight coordinator and make sure to ask if they will need to be excused during this event to compete in another. If there are some that will have to be excused, explain to them as a group the rules on absence, particularly how it will be applied by you in this meet. This is an area for more misinterpretation since the rules vary from sanctioning body to sanctioning body and meet to meet.
8. Once it is determined if there will or will not be flights, announce the competition order and who is in which flight. The Games Committee should set the order. If not, it should be random draw by lot.
9. Announce warm-up times and who can warm-up when. The Games Committee normally sets the amount of time for warm-ups before each flight. But a good rule of thumb is to allow 3 or 4 throws per entrant. This translates into about 1 1/4 to 1 1/2 minutes per athlete or about 15-18 minutes for a flight of 12. If there is a general warm-up period, then use about half of the time for all entrants and the other half for split between flights; i.e., for two flights of 8 it would be 10-12 minutes general and 5-6 minutes for each flight.
10. Check any implements before warm-ups and before the competition proper to be sure they have gone through Weights and Measures. Only marked implements can be used for warm-ups or the competition proper. Use of an unmarked implement, even in warm-ups, is grounds for disqualification. If an overweight but otherwise legal implement is being used for warm-up only, make note of it so it can be pulled before the competition starts.
11. It is now recommended by USATF that a competitor take no more than two warm-up throws for each turn in line at the competition area. This is a good guideline for all competitions so that no one athlete can hog the circle..

#### WARM-UP TIME:

1. In the throws, only warm up with officials in the field. This also helps the marking officials determine where they should position themselves for each athlete for fast and accurate marking during the competition since they will know the approximate distance for each competitor. Do not let athletes retrieve their own implements. Carry implements to the left side of sector (Officials right) and if there are enough officials, have them help carry the implements back to the circle. For safety reason it is best to be out of the sector whenever possible. Have several throws followed by time to retrieve the implement while no one is throwing. The high school rule book requires an official or coach be present at any time an athlete is throwing. The penalty for not having someone overview is disqualification upon a repeat performance.
2. Warm-ups are limited to a maximum of 15 minutes per flight for the NCAA (Rule 6.4.1) starting in 1997. As a rule of thumb, you should allow enough time for each competitor to get at least two attempts - preferably 3 or 4 attempts - during warm-ups, particularly on cold days or unless there is a separate warm-up area. That means you should allow about 20-30 seconds per throw. If you have flights, make sure the warm-up times are consistent for each flight plus any warm-up planned before the finals.
3. At the beginning of warm up period, let everyone know how many throws or how long the circle or runway will be open for warm ups. If there is a general warm-up period for all flights at once before warm-up for individual flights, use the same formula as above for estimating the time to be allowed. In championship events, warm-ups are sometimes done in order, normally two throws in order, particularly if there is a practice or warm-up area.
4. Always close the warm-up period off with about 2-3 minutes to go, so there is adequate time for instructions and introductions if there will be any. These need to be coordinated with the announcer. It is best to do this by getting in the warm-up line a few minutes before the end of the warm-up period. Thus, everyone knows when the time is over and no one can try to sneak in one extra attempt. Announcing how much time is remaining every few minutes or having a countdown clock also helps.
5. Following warm-ups put the measuring tape out from right side of circle or runway to a point on the right sector line as seen from the circle. Implements are carried off to the opposite or left side (field officials' right).
6. Sweep runways or circles.

7. Make sure sideline areas and area behind field event are clear of unauthorized people when the competition begins. It often distracts athletes to have anyone directly behind the cage.
8. Any photo boxes should be at least a meter off the sector line and about 35 meters out from the measuring point at the circle. All photographers should be standing.

### INSTRUCTIONS:

1. Go over how you plan to conduct the event, including all the applicable rules for the event. Early in the season, go over any recent rule changes.
  - a. Start from a stationary position from inside the circle or on the runway.
  - b. Do not leave circle or runway until the implement hits the ground. (In high school, until the official says, "mark".)
  - c. Leave by the back half of the circle (under control in HS) or behind the toe board extended for the javelin. Point out circle foul lines or the arc lines extended. (You can enter the circle or runway from any direction.)
  - d. Point out sector lines and indicate that fair throws must be inside of, not on, a sector line.
  - e. Tell them if you will be measuring in feet and inches, or meters and centimeters. Point out that the metric measurement is the official distance. (Only HS and some Junior Colleges recommend use of Imperial units any more.) As a convenience, if you have a common zero tape, it is nice to read both the metric and imperial distance. The NCAA recommends the announcement of both. If you are not going to do this, then read in the units you are recording and hand the athletes or the sign board operator a conversion book.
  - f. Tell them they have 60 seconds to start their trial from the time they are called up. Tell them if you will announce 15 or 30 second remaining, as appropriate for USATF/IAAF or NCAA meet, or just raise a yellow flag. I recommend using both the flag and saying 15 (30) seconds for all but the javelin where the flag can be seen easily by the athlete preparing to throw. The flag must be held up until the time elapses. If a trial is started before the time is up, it is OK; it need not be completed in the time period. Likewise, if a throw is underway when the 15 or 30 second mark should be announced, wait until the thrower has stopped a throw before calling out the remaining time since it might disturb the athlete. Tell them that if an athlete passes after being called up, it will be considered a time foul. Under such circumstances in a USATF or IAAF meet, you should not call up or start the time for the next competitor's attempt before the time period for the passing competitor has elapsed, unless the athlete wants to start early. That is, a field athlete has the right to the time he had reason to expect to have to get ready before the preceding athlete passed. In the case of an excused athlete who is not there to take their turn, then in USATF and IAAF the athlete is assumed to have passed that attempt once the time has elapsed. This would normally occur at the end of a round.
  - g. Tell them that you will indicate \_\_\_\_ is up, \_\_\_\_ is on deck and \_\_\_\_ is on hold or at the ready. Alternatively you can say \_\_\_\_\_ is up, \_\_\_\_\_ will be next, followed by \_\_\_\_\_. Inform them they should be ready to start their turn when called. If for some reason two athletes are using the same implement, you should wait until the implement is retrieved and returned to the circle/runway before calling the subsequent athlete up. Some officials like to make a preliminary call before the call up so the athletes are ready to enter the circle. This can be done when you go into measure a throw or while you are leaving. Just make sure the timer and the athletes understand when the time period to start their attempt is beginning, this can be done by announcing it, raising the flag or removing a cone in the circle or on the runway.
  - h. Check for the number, ownership, and location of runway marks in the javelin. Two marks are allowed in NCAA, IAAF and USATF events. The number of marks in high school throws is left up to the Games Committee. In a NCAA meet shoes may not be used as markers.
2. Tell them how many athletes qualify for the finals and what is required. If 8 or less, all get 6 trials (except if the Games Committee had decided to have just 4 final throws and no preliminary throws). High school require a fair throw in the preliminary throws to advance to finals. The NCAA now just requires an attempt in the preliminary round. legal or not. Normally eight (or nine if nine lanes are used around the track) go to the finals. In IAAF and USATF, ties for the last qualifying position are broken, when possible, before advancing to the finals. If an athlete does not have a fair throw but is advancing, then they will throw first, in their original order during the preliminary rounds.
3. Tell them not to go into the sector (stay behind the flags) or cross the runway, and that they should retrieve their own implement from the side of the sector where the official will place the implement.
4. Tell them what is a foul trial:
  - a. Over the allotted time and when the time will start.
  - b. Stepping on top of circle, the arc or toe board.
  - c. Walking out of the circle or off the runway before the implement hits the ground or impact area, and in high school leaving before the word "Mark" is called and/or out of control.
  - d. Walking out the front half of the circle, over the arc or arc lines extended.

- e. Improper form.
  - f. Stepping on or over the runway parallel sidelines in the javelin during the run up.
  - g. Not indicating that you are passing before being called up. (Results in a time foul.)
  - h. Not starting from a stationary position in the circle or on the runway.
  - i. Implement lands on sector line or outside of the sector.
  - j. the case and an athlete may stop and restart the attempt assuming no other violation has occurred.
  - k. The discus hits the cage and lands in the sector in high school meets only.
  - l. If for some reason an athlete is taking consecutive throws in USATF or IAAF meets, then they are allowed two minutes for the second throw. This normally won't happen since they are only allowed one throw per round.
5. Recheck their implements for markings to insure that the Weights and Measures staff has checked all implements being used before beginning the competition. Throwing of an altered implement or implement not inspected, even in the warm-up period, is grounds for disqualification.
  6. Check hands for tape. This also can be done by observing the throwers while they are taking practice throws. Generally taping of hands or fingers or use of gloves is not allowed in throwing events. The notable exceptions are the hammer and weight events. Taping of wrists and the use of belts for support are OK. See the previous section on Aid or the individual sections for more detail. All rules allow the taping of individual fingers and use of gloves in the hammer and weight events. The NCAA allows wrapping of individual fingers but joined at the base of the fingers like a glove (see description in previous section on aid).
  7. Tell them to put their implement down or ask permission if they want to leave the circle or runway and start a fresh trial. Although not necessary it will insure that a foul is not called. However, the time should not be reset unless the head event official decides that due to special circumstances it should be.
  8. Tell them they can put talc, spray or similar substance for a better grip on their hands, or in the case of the hammer or weight, on their glove but not the implement. The NCAA is the exception where chalk can be put on any of the implements. They cannot put anything on their shoes or in the circle. If they put it on the implement they risk having the implement declared illegal for the competition and/or disqualification from the event, particularly for a repeat incident or after they have been told. Chalk on the neck for the shot put is acceptable and specifically stated in all but the high school book. Why is this a rule because if implement are common some athletes may want material on the implement but others may not. Note in NCAA, Masters and High School the implement does not lose its ownership identity and use by some one else must be requested. This is true also for Youth Javelins only.
  9. Confirm those that may have other events going on at the same time and explain to the group what they must do when they leave, and when and if they can have make-up throws.
  10. Explain the use of the red and white flags to indicate a fair or a foul attempt, and yellow to indicate limited time remaining. In case of the high school competitions, the head official needs to say "Mark" when the implement lands and the athlete must be under control when leaving the runway or circle. These are no longer a requirement and generally are not done in other meets. Explain that if the yellow flag is raised, they should continue to complete their throw in a timely fashion.
  11. Have athletes remove any objects which might impede their throw or may fall while they are competing and which could cause a potential safety problem. Note that no jewelry is allowed on high school athletics since 2002. Watches are not considered jewelry, and only religious medals or medical brackets taped to the body are allowed.
  12. Read the competing order.
  13. Line up competitors for introductions, if needed.
  14. Inform the competitors that once the competition has begun, they are not permitted to use implements or the runways for practice with or without implements until they are called up.
  15. If possible, implements should be controlled and only picked up by the athletes when they are called up "on hold". This conforms to international and national practice. Some officials like to make the preliminary call, and then after the "on hold" say "and 'xxx' is up", thus indicating when the clock is started. Alternately you can use the removal of a cone as the start of the time increment.

#### THROWING COMPETITION:

1. Start your watch or the clock when athlete is called up.
2. Watch the entry for circle events, and once the athlete becomes stationary, start watching for fouls.
3. Watch to see if the athlete is stationary somewhere in the circle or on the runway at the start.
4. Watch the feet.
5. Watch the style.
6. Watch the implement hit. The field official should raise a red flag if it lands on sector line or out of the sector. If it is a high school meet, call out "Mark", so the athlete can leave the circle.
7. Watch the athlete leave by the back half or behind the arc after the implement has hit in the field. In high school, the athlete must be under control when leaving the circle or runway.

8. Check with other circle or runway officials and field officials to see if they are indicating a fair or foul trial. Raise the white flag if there is no foul and the red flag if there is one. Always wait until throw is completed before raising a flag or calling out "Mark" or "no Mark". It is better to just raise the flag, except in high school where the verbal announcement is required. This way an athlete won't be hurt by being distracted or trying to stop in the middle of his/her throw. Hold up the flag long enough that it is acknowledged by the appropriate field officials usually after they have marked the throw in the field.
9. Tell athlete the reason for a foul call.
10. If fair, mark the point of impact closest to the circle or arc and measure the throw.

#### MARKING THROWS:

Generally, there are three kinds of impact areas used - grass, dirt or gravel, and synthetic turf. Each has its advantages and disadvantages depending on the weather conditions and the event. For example, dirt can be raked to remove the old marks, but if the impact area has not been properly prepared, there may be old marks just below the surface which may interfere with getting clean new marks. It can be a problem in the rain, filling with water. Gravel for the shot put is easy to rake, but the holes tend to be exaggerated and don't conform well to get an accurate front mark. Dirt or sandy soil is better choice for the shot. For grass, both the length and type are important. Some marks can be lost if the javelin or discus is pulled out before being properly marked, or if the grass hides the mark as with many southern grasses. This is not normally the case for the hammer or the weight events. Likewise, the weather can be a help or a hindrance. Slightly damp grass can indicate where an implement hit because of grass lay down or damage or the relative dryness of the area. Normally, dirt or gravel is used for the shot put and grass for the other events. But there are more and more synthetic surfaces. Marking on synthetic surfaces may require some special care and/or chalk on the implement. Both synthetic and grass runways are used in the javelin. Metal foul boards for the javelin are outlawed in all but high school competitions starting 2006.

Before the start of the competition and certainly during the instruction period, the field officials should do their best to remove/fill in previous marks from the impact area. Filling in the holes will help you to be able to do a better job in getting and measuring accurately the new mark. Covering the hole also helps the grass grow back and reduce the tripping hazards in the field. This is particularly true for hammer fields. If the impact area is dirt or gravel, then rake the area after each round or flight. Fill in the holes with your foot after each attempt.

When positioning yourself as a marker, always try to be to the side of where you expect the implement to land and slightly long of the expected mark. For safety reasons, you should not be closer than 15 feet to any throw. It is best to be at side or even outside the sector when possible. Which side depends on the wind and if the throw is right- or left-handed. This is for your safety since most implements tend to skip on impact, as well as to help with accurate marking, particularly for the lighter javelin and discus. You can never be sure which way an implement may go after it hits the ground. Some have been known to go 90 degrees from the thrown direction. Know the throwers. See where they throw in warm-ups so you can be properly positioned to get to the mark easily, quickly and safely. Be mindful of the wind direction and if the thrower is left or right handed since, in the longer throws, this should guide you as to which way to move if the implement gets too close. This is particularly true for the javelin and discus. If you move the wrong direction, the implement may tend to follow you. Don't freeze and wait too long to move if the implement is coming at you. Think about which way to move before the throw. Since most throwers are right handed, you normally will want to move to your left, which is not normal for right-handed people.

Markers should triangulate on the mark. The closest marker should move to the mark and then confirm with the other markers that he/she has the correct spot. The other markers should remain still or walk slowly to the mark to make sure the closest marker doesn't lose the mark because he/she tripped or had a bad mark to start with. Likewise, the field tape puller also can act in this capacity. As you sight in on the spot, look for a nearby mark; i.e., a discoloration of the grass, a flower or a piece of paper. When you get to the area where you thought you saw the implement hit, always look and feel the ground for a mark in and around that area. It is surprising how often you will find it. Make sure it is a fresh mark (see techniques below). Mark the best point you have. Do it with authority and quickly. Delays only open the door to questions and protests. Side views of the landing are the best since your depth perception has less of an impact.

Normally, the weight and the hammer do not pose any particular marking problems unless the impact area is in very poor repair. These implements are heavy enough that they leave clear marks except on a very dry or very wet field. Both cause problems. On a very wet field, you may not be able to smooth the impact surface adequately so that to avoid the problem of getting two images if the implement lands near or on a previous mark. However, unless it is raining, you can often tell the new mark from the old based on the dryness of the soil. The older mark tends to be dryer being exposed to the air or sun longer. If you get a dual mark; i.e., an implement lands in a

previous mark, use your finger to determine where you think the implement first impacted. In a dual hammer hole, you often can feel the change in contour separating the two throws. Do your best to measure from the point at which the implement would have hit if there had not been a hole; i.e., the normal ground level. On a very hot or dry day, the marks in the impact area may dry so that they can not be easily filled. Always mark the spot before you try to extract the implement so the true mark is preserved. On very wet fields, you can have a problem removing the hammer and can destroy the mark when you try to extract it. If it lands in standing water, the mark may be covered up and lost. Always mark the spot even if there is a red flag at the circle unless it is clear the athlete fouled the throw. The throw may be protested and you will need to measure the throw to protect the rights of the athlete.

Always use a separate marker from the one for the tape since it is not uncommon on the longer throws to have the tape pulled out of your hand, pulled out of the ground, or broken. With a separate mark, you won't lose it while you replace or retrieve the tape. Always sight down the tape to make sure it is straight. The people in the field have a better view than at the circle or runway. It is useful to use a long stick or rod to connect the tape. This allows the tape puller to avoid bending or kneeling down to measure. It certainly will make a difference at the end of the day.

The mark to be used for measuring is the first mark made by the implement as it comes in for its initial impact. That is the first mark left by the ball, the discus, or the javelin point; i.e., the mark of the ball, discus or point closest to the circle or runway. A mark made by the grip, wire or shaft should not be used. In Youth and high school javelin competitions, throws that land flat or tail first are measured. Although this sounds simple, it is easier said than done. But with a little practice, you can become proficient. Keep your eyes on the part of the javelin that you think will come down first. Don't try to change from point to grip or tail to grip at the last moment. If you do, you will probably miss both points. You can always lay the javelin down to get the required mark if you know where the part of the javelin you saw hit.

It is useful, if you have enough officials, to assign one of them, usually the person with the tape or the alternate marker, to keep an eye on the circle for the indication of a foul throw so that he/she can inform the rest of the field crew. In the field, always mark the throw even if it appears to be a foul. There might be an appeal. If there is an immediate appeal on a foul call, the attempt should be measured but not announced to anyone unless the appeal is upheld. This will protect the rights of the competitor. Therefore, if you are in the field, don't be too quick to pull the mark of the distance if there seems to be some controversy about the throw or if it appears to be near a record distance. Do not be involved in measuring foul throws during or after competition. It only causes problems. Several of the rule books now clearly state that foul throws should not be measured.

Finding the mark for the javelin, particularly the lighter implements, or the discus can be a real challenge. In both these events you need someone in the field with some past experience. For the javelin, the length and type of grass is important. For example, in St. Augustine grass or other plug type grasses you don't dare pull the javelin before you mark the point because you'll never find it again. But then you often can find a tear in the runners where the javelin entered the upper grass surface. You will get a tuft to stand up. In Rye and Bluegrass you can look at the bent blades to see where, on a nearly flat throw, the javelin hit. If the grass is too short, you can't observe this. If it is too long, the officials tend to track it down with the same effect. Use your fingers to run along the shaft mark to find the break in the ground where the point may have hit first. When a competition allows flat throws, they should be measured from the front of the grip. In such cases it is best to always keep your eye on the point. Let the official on the sector line determine if it is flat or point. Moving your eye from one point to the other to determine the point of first contact may confuse your perception of the mark, or you may end up looking at the wrong point when it hits. Remember the javelin can always be retrieved and then laid down along the line of the throw or the impression left in the grass to find the front of the grip. On nearly flat throws you may have trouble finding the point mark since the shaft will tend to flatten the grass before the mark. But use the line on the field to look for the point mark. This was predominately a problem with older and lighter javelins. With recent changes, that problem has been greatly reduced. Often throwers are using javelins rated for distances that they only rarely reach. This implement will tend to come down flat or tail first.

In the discus, run your finger up the mark if the discus turned on its side when it landed. If the discus landed flat, look for the impression on the grass and make your best judgment as to whether the implement landed on its flat side or the leading or trailing edge first. Using your fingers, you can often find the impact point. Remember to trace it to the point closest to the circle.

For the javelin, one official should be low and outside the sector to determine if the point lands first. That official should not be a marker. The NCAA mandates the location of this official starting 2006. Rule 6.10.3.

**MEASUREMENT:****IN THE FIELD:**

The field official should set the tape and let the tape puller at the circle straighten it. Let him know if it does not appear to be straight. When using a fiberglass tape, pull it taut and then release most of the tension for a proper measurement. Remember you are a team. In high winds or long grass, you may have to straighten the tape part way in. For the throws, the tape should be pulled through the center of the circle. If you keep the tape low when there is wind, it is easier to get the tape straight.

If the circle is higher or lower than the area in front of the circle, or you are using a steel tape, additional tension may require keeping the tape from sagging and ensuring the correct measurement. Try to keep the tension consistent for each thrower. Note with fiberglass tapes, once the tape is straight, much of the tension can be eliminated for the most accurate reading. For the shot hold the tape at the field mark at about the same height as the top of the toe board.

Always mark the indentation with a separate marker, such as a screwdriver, or small barbecue skewer. The tape should be on a separate stake or marker. This avoids problems if the tape breaks or the tape puller pulls it out of your hands. Always make sure the tape is straight and the zero end is in the field. Check the zero point to determine whether it is at the end of the tape or a point up the tape. Make sure the field tape puller knows where the zero is and places it at the part of the mark closest to the circle or foul arc.

**AT THE CIRCLE OR FOUL ARC:**

1. The tape puller should pick up the tape as he/she gets to the front of the circle or walks to the javelin mark. Keep slight tension on the tape to keep it straight. Pull the tape through the center of the circle from behind the circle or mark. If straight, then release most of the tension. If not straight, move the tape until it is. In the wind, this may require you to move beyond the center of the circle and then come back. Keep the tape low and out of the wind. If possible, pull the tape from behind the circle, so that you do not track any mud, dirt or grass into the circle.
2. The recorder should be on the left side of the circle as you face the field (since most tapes read from that side), write down the measurement read, and repeat it as written. The reader should acknowledge that the correct reading has been recorded. Record the measurement clearly on the event sheet and, if there is room, record the English reading (only if they have the same zero on tape) at the side. (In High School meets where the Imperial measurement is the one recorded.) This can help if there is an error in recording the figures. Note the correct procedure is to convert the metric measurement using the tables since there is a round off factor in converting from metric to imperial measurements.
3. Announce the measurement clearly so both the athletes and the recorder can hear. Give the metric distance first, and then the imperial distance if you want. In big meets, the reader also records the value as backup. Two officials should read the tape whenever possible. For example, "60 meters even, that is approximately 196 feet 10 inches". I like to say if the throw is an improvement or the thrower has a better previous best by saying, "That's an improvement" or "He/she has a better one." On the last throw, I announce the throw and then the best mark for the day. "60 meters even, 196 feet 10 inches. He has a better one and will finish the day with a mark of 65.12 meters." If you have a signboard you may not need to do it. Some people don't like to give the imperial distance, but I think it helps the spectators and even the athletes because we still don't understand the metric system.
4. If the throw is a record, you will need confirmation by three certified officials under the supervision of the field referee at both ends, so don't pull up the mark too fast. Likewise, you will need to impound the implement to have it rechecked in all but high school meets, and I would recommend it for all meets. (see USATF rules 260,261,262, and 264 for Records)
5. Remove the mark only when the circle official has gotten up and left the circle area in case there is a protest or a record.
6. In filling out the scoring sheet for the throws, the recorder should use F for fouls, P or - for a passed attempt, and record the distance as follows: For feet and inches, 16'-4 ½" and for meters and centimeters 16.37 m.

**TIMING OF MEASUREMENTS**

Generally all throws should be measured immediately. This is required in USATF, WMA and IAAF meets. However, both NCAA and high school rule books don't require this. They sometimes use numbered stakes to indicate the furthest throw in the preliminary or final rounds and only measure that throw. This saves some time. However, the system has several problems which must be accommodated if it is used. It is always hard to communicate which athlete is up so that the right stake is found and moved. This can be done by calling out the number or using a performance board at the circle to indicate the athlete that is up. Another problem is



making sure that the new mark is more than or less than the previous one if close. This can be handled by having a second mark in the field and measuring both and recording only the best one. Finally it has the problem that if a mark is improperly moved or kicked, there is no way to recover that mark. The only alternative is generally to give the thrower an additional mark which might result in a better or a worse throw but in any case increase the number of opportunities that athlete has. For these reasons I do not recommend its use although is common in high school and junior college meets because of the lack of officials and time constraints. If you use it make sure there is good communication between the circle and the field to avoid the common problem of moving the wrong marker.

#### CONTINUING COMPETITION:

Continue on until all preliminary throws are taken. If a field event competitor is entered (checked in) but late for the start of the competition, the competitor will not be allowed to take missed trials but may take any remaining ones for which the athlete qualifies. In High School and NCAA sanctioned events an athlete must check in before the first throw or be scratched from the event. If there is a second flight, let them warm up and proceed again. Warm-ups for all flights and before the finals (if needed) should be the same length. When you have all preliminaries complete, or finals if less than 8, score the places. Have someone else check the scoring when the recorder has finished. The throwing order for the final is in the reverse order in which they qualified for the finals. Thus, the athlete with the best throw in the preliminary throws will be last, and the one with the last qualifying throw will be first. Announce the finalists and let them warm-up. Continue as before, giving each finalist an additional three throws. If there is only one flight, or all finalists are in the last flight, then there should not be a warm-up period unless it is a NCAA event. In major competitions, like the national championships, there may be another reordering before the last attempt. If an athlete qualifies for the finals but subsequently drops out because of injury or other reason, that athlete will not be replaced.

#### AFTER THE COMPETITION:

1. When the finals are complete, do the scoring and checks and get the officials to sign the sheet. Note all attempts count. If there should be a tie, then use the value of their second best throw to break the tie. Confirm the results with the FieldLynx official or the second recorder.
2. Announce the results to the competitors and then give the results to the runner, referee or the announcer. If at all possible keep a copy if you are the head. Too many times results are lost on the way to the scorer.
3. Close up the venue so no one will use it without supervision until after the meet. This can be done by putting a cone in the ring, on the runway, or closing/locking the cage.
4. Check in with the head field judge or referee to see if you are needed to officiate at another event.

#### SUGGESTED PERSONAL EQUIPMENT LIST FOR THROWING OFFICIALS

Band Aids  
 Baggies (2 gallon to fit over clipboard in case of rain)  
 Big Clips for clipboard paper sides  
 Blank Numbers (for lost numbers)  
 Bug Repellant  
 Cell Phone (turned off for emergency call)  
 Chalk  
 Clip Boards (Clear one to see schedule through back)\*  
 Cone, Small (circle closure)  
 Conversion Book  
 Distance Markers (Laminated)  
 Ear Plugs (for events near starter)  
 Eraser  
 Event Clock (battery operated time clock)  
 Extra Key Rings to fix tapes  
 Field Event Forms  
 Field Measuring Rod (2 or 3 piece to fit in bag)  
 Flags (red, white and yellow)\*  
 Foot Mat at Circle to clean feet  
 Garbage Bags (for Equipment Bag or poncho if rain)  
 Highlighter, several colors  
 Instruction to Athlete Cards (List of rules to cover for each field event)  
 Labels (Address for Implements)

Markers (screwdrivers or skewers)\*  
Magic Markers (Black) or Paint Sticks  
Megaphone, Small and battery operated  
Membership Forms (USATF)  
Officials Address List (Local)  
Officials Application Forms  
Paper Towel to put between baggie and between sheets if raining  
Permanent Markers and/or paint stick  
Pens or Pencils (particularly if raining) \*  
Pencil Sharpener  
Plastic Ties (various sizes for netting and signs)  
Plastic (8 1/2x 11) Paper covers  
Plastic bag (2 gallon size to fit over clip board in case of rain)  
Post Its™ (for reordering finals with multiple pages)  
Record Forms  
Record List for Competition (National and World Records)  
Rubber Bands (for Clip Board)  
Rulebooks (IAAF, USATF, NCAA, NFHS)\*  
Safety Pins  
Stapler and Staples  
Stop Watch\*(Yellow flag)  
Suntan Lotion (Rating of 15 or better) \*  
Tapes, Measuring  
    Long Throws: 330'/100 meter Fiberglass\*  
    Long Throws: 100 meter, steel tape for records  
    Short Throws and Horizontal Jumps: 30 meter or 50 meter fiberglass tape  
    Short Throws 35 meter steel tape for records  
Tapes  
    Adhesive\*  
    Duct (Silver, White, Yellow, Red)  
...Electrical (several colors)  
    Masking  
    Scotch  
Time of Day Clock (hung near event)  
Tools  
    Allen Wrenches (tighten standards, performance boards)  
    Adjustable Wrench (4")  
    Hammer  
    Knife  
    Pliers  
        Needle Nose  
        Regular  
    Screwdrivers (as markers and tools)  
        Philips  
        Regular  
    Scissors  
    Vice Grips  
Towels  
USATF Directory  
Water Bottle \*  
Wind Sock (Discus, Javelin)  
Wrist broom

## **Clothes**

Extra Pair of Socks (particularly if wet in morning)  
Extra Pair of Shoes if inclement weather or wet field  
Hat \*  
Sweater or Jacket (depending on time of year)  
Pull over Rubbers or Rubber shoes

Rain Suit or Poncho  
Gloves (cold weather and raking pits)  
Sunglasses\*  
Wind Breaker  
Work Gloves for pulling hammer  
Hand Warmer  
Umbrella

\*Should always have these as a minimum.

**Other Things to Carry:**

Calculator or Feet to Metric Converter  
Carry-on Suitcase with wheels to carry it all  
Flagging - 2 or 3 50' lengths  
Folding Chair  
Hammer Measuring Extension  
Package of Wooden Shims for hammer ring  
Portable Walkie-Talkies (2)  
Spike Wrench  
WD-40 or Oil  
Whistle

Thanks to Jim De Marco, Lane Dowell, John Du Bois, Winn Eggers, Tom Heisey, George Kleeman, the late Carl Mosely, David Post, Bob Tice, and Rhea & Jane Warren who sent in lists of what they carry.

## APPENDIX A

### IMPLEMENTS

#### WEIGHTS AND MEASURES:

Since all of the throwing events use implements, all implements should be inspected before the competition to make sure they meet the weight and measure standards and are safe to use. Throwing an implement that is altered or not inspected is grounds for disqualification, even if it occurs during the warm-up period. Make sure you know the mark and color for the day, and check each implement in the field as it is retrieved each time. The shot, the discus, and sometimes the hammer are the offending events since an extra implement can easily be carried onto the field in athletic bags. It is more difficult for javelins to get there unnoticed. For details about how to be a Weight and Measures Official, see *The Weights and Measures Handbook*, or contact George Kleeman at 5104 Alhambra Valley Road, Martinez, Ca 94553-9773, or E Mail [george\\_kleeman@comcast.net](mailto:george_kleeman@comcast.net). It can also be downloaded from the Officials web page at [www.USATFofficials.com](http://www.USATFofficials.com) under Training.

#### IMPLEMENT SPECIFICATIONS:

Why do you need to know about this subject? In many meets there may not be an Inspector of Implements available, and so you as the event official will have to enforce the implement requirement rule. You need to know enough to know if the implement at least appears to meet the requirements. Likewise, many competitors, even world class ones, try to use a different implement in practice, heavier or lighter, to gain psychological advantage over their opponents. If you are in the field retrieving implements, always check the implement each time for the inspector's mark and general conformance to specifications. An implement not conforming should be held by the head judge until the competition is over to make sure an athlete doesn't throw an improper implement. The athlete throwing an improper implement should be warned that a repeat incident is reason for disqualification if they weren't pre-warned before warm-ups started. It is important to check the implements early and during the competition, particularly the shot and hammer, because the marking may become blurred or even wear off during the competition. Look for a distinguishing mark so you will recognize the implement in the future. In the past, there were major differences between the javelin specifications in the various rulebooks. But now, all five governing bodies have agreed to use the IAAF standard for the 600g and 800g javelins, which will simplify matters considerably. However, the high school javelin will still allow for the use of the rubber tip and has no contour requirements, and there are two additional WMA weights - namely 400g and 500g and a Junior implement at 700g..

Below are the general weight specifications for most classes.

#### **SHOT:**

The shot shall be a sphere made of any metal, but not softer than brass. It can be solid or filled with a smooth surface. The weight varies depending on age group and governing body as shown below. Internal movement by feel or sound is no longer a restriction. For USATF and IAAF there is also a roughness test, i.e. a shot may not be rougher than N7.

	Men	Women	Juniors Men
High School	12 lb.	4 kg	
USATF/IAAF	7.26 kg (16 lb.)	4 kg	6 kg
NCAA	7.26 kg (16 lb.)	4 kg	

Note: Junior Women and Youth Girls use the 4 kg shot.

See USATF Rules 188.3-5 for the shot specifications summary table, and then Rule 332.3(g) for the weights used in the Master's age groups, and Rule 301 for the weights used in Youth age groups. Note - There should be no indentations or flatness of sufficient size to allow a better grip. Also note - generally, except at possibly the highest levels, cast shots with the weight stamped on them are legal.

#### **DISCUS:**

The discus shall be made of wood or other suitable material with a metal rim, the edge of which shall be rounded into a true circle. The one exception to this definition is in competitions using the high school rules, which still allow the use of a plastic or rubber disk without the metal rim. Such rubber or plastic disks should not be used, even in warm-ups, in any other competition. Note - metal plates which are set flush into the center of the sides are optional and need not cover the whole flat spot. Each side should be identical and without indentations, projections, or sharp

edges. The taper shall be in a straight line, from the curve of the rim to a circle, with a radius of 25 mm to 28.5 mm from the center of the discus. The edge shall be smooth. The weights used are (See USATF Rule 189.3):

Men	Women			
	High School	1.6 kg	1.0 kg	
		Men	Women	Junior Men
	NCAA	2.0 kg	1.0 kg	
	USATF/IAAF	2.0 kg	1.0 kg	1.75 kg

Note that the women's discus is the same until age 80 when it drops to 0.75 kg.

For USATF, Youth, and Master age group requirements, also see USATF Rules 301 and 332.3(g) respectively. Implements can have internal movement.

#### **HAMMER:**

The hammer consists of three components - the head, the wire, and the grip. The head has the same measurements as the shot but is lighter, since the weight of the whole implement, including the handle and wire, is the same as the shot. There can be no internal movement in the hammer, and the center of gravity can not be more than 6 mm from the center of gravity for the ball. This means it must balance on a sharp edge circle, which is 12 mm in diameter. The wire must be spring steel of nominally 3 mm in diameter. The wire is looped at one or both ends to attach to the ball and the grip. Check for wear or thinning just above where the wire is twisted to make the loop. Likewise, make sure that the wire ends do not protrude such that they might get caught in the netting. I recommend that they be taped. At the ball, the attachment is by means of a swivel, which may be either plain or ball bearing. The grip must be attached by a loop. The grip may be either single or double looped construction, but must be rigid and not stretch appreciably when thrown. The inside width of the grip is a maximum of 130 mm, and the maximum length 110 mm. The diameter of the wire loops is limited to a maximum of 1.95 mm in the USATF meets. (See USATF Rules 192.5-10.)

	Men	Women	Junior Men
All	7.26 kg	4.00 kg	6.00 kg
M50-M55	6.00 kg		
M60-M65	5.00 kg		
M70-M79	4.00 kg		
M-80-M95	3.00 kg		
W50-W95		3.00 kg	

Note: Junior Women and Youth Girls throw the 4 kg hammer.

#### **WEIGHT:**

There are four types of weights - namely, the normal indoor weight, the outdoor weight, the Superweight, and the Ultraweight. The implements from 12 lbs to 35 lbs are more common and are considered the normal weights. Weights from 25 lbs to 56 lbs are considered the super weights, and those from 98 to 300 lbs are the Ultraweights. The same type specifications apply to the weight and super weight implements. The Ultraweights have much simpler specifications at this time. There are both weight and ultraweight pentathlons. The former involves the hammer, shot, discus, Javelin, and weight throw. Starting in 2005, the Ultraweight pentathlon has been codified and involves throwing five separate weights. The implements weighing between 12 lbs through 300 lbs depending on the age group as defined in Rule 202. The weight pentathlon has been around for a number of years and is a normal part of the Master level competitions. The Ultraweight pentathlon was recognized as a legal event by USATF for the first time in 2005. Weight competitions have been primarily a USA event until recently. The World Masters do have the weight pentathlon. There is weight competition indoors for both Men and Women in the NCAA (Rule 10-9). The men throw the 15.880 kg (35 lb) implement, and the women throw the 9.080 kg (20 lb) implement.

The construction of the weight and superweight are similar to the hammer, but connected normally with a chain, although wire is permissible in the NCAA. The size of the head is fixed, along with the overall weight and length of the implement. The overall length of the implement from the inside of the handle to the outside diameter of the head when hanging is 40.64 cm. The WMA spec is slightly different and allows a length of 41.00 cm. The ball shall be a solid sphere made of a metal not softer than brass, or of a shell of such metal, filled with lead or other material. The handle may be of round metal, but not to exceed 1.27 cm in diameter, and may be triangular or single looped construction with no side to exceed 19 cm inside measurement. It must be rigid and not appreciably stretch when being thrown. The connection may be with two loops of steel line or with welded steel link which shall measure 9.525 mm in diameter. There are slight differences between USATF and NCAA rules, so refer to the appropriate

rulebook. The connections are similar to the hammer. WMA is now using the weight, although the IAAF still does not. WMA does allow the use of a hammer handle, particularly for the lighter implements where it won't stretch.

The Ultraweight in USATF has only two specifications, namely its minimum weight, and the distance between the inside of the grip and the top of the weight, which is a maximum of 15.24 cm.

See USATF Rule 195 for the various weight specifications which vary from 12 lb. to 300 lb. See Rules 301 and 332.3(g) for weights thrown by various Masters age groups in the weight, Superweight, and Ultraweight classifications. In 1999, a new requirement was added of no internal movement if there is a filling, and center of gravity shall not be more than 9 millimeter from the center of the sphere.

	Men		Women	
Open	25.40 kg	15.88 kg	9.08 kg	
M30-M55	25.40 kg	15.88 kg		
M60-M95	15.88 kg	11.34 kg		
W30-W45			11.34 kg	9.08 kg
W50-W95			9.08 kg	7.26 kg

Note: 300 lbs. = 136.100 kg, 200 lbs. = 90.800 kg, 98 lbs. = 44.500 kg, 56 lbs. = 25.400 kg, 35 lbs. = 15.880 kg, 25 lbs. = 11.340 kg, 20 lbs. = 9.080 kg and 16 lbs. = 7.260 kg.

### JAVELIN:

There are five weights of javelin - 400g, 500g, 600g, 700g, and 800g. The javelin has the most specifications of any of the implements. Because both the 800g and the 600g implements have been changed since 1986, and two new javelins were added in 1999, thereby increasing the number of legal implements, there are a lot of different spec implements out there. In 1986, the 800g javelin thrown by men was modified by moving the center of gravity to shorten the distance it could be thrown so that the event could be kept in the normal stadium. In 1991, the IAAF and USATF changed the contour of the tail of the 600g javelin to try to make the flat throw a problem of the past. In 1999, they made further modifications by moving the handle forward a few centimeters. The distance from the center of gravity to the tip was shortened by 30 cm to 920 cm. This has helped to get the implement to land point first. The high school converted to the IAAF specification in 2002. Now all javelins are intended to meet the same international specifications. For the first time in a while, we will have to deal with only one legal javelin per weight. However, because of the cost of javelins, we will still continue to have some old javelins presented for checking until they wear out. Those will be the pre-1986 800g (and old high school) javelins, the pre-1991 and pre-1999 600g (old high school), and pre-2004 Masters. Normally, the javelins conforming to the new rules will be so marked by the manufacturer. However, at least some of the 1990 and earlier 600g javelins do pass the new requirements, and so may not be marked with anything other than "meets IAAF standards". In 1991, the minimum diameter of the 600g implement at the mid-point of tail and the 150 mm point was increased from 70 to 90 and from 30 to 40% of the maximum diameter in front of the grip, respectively. The NCAA, the USATF, and IAAF require that the shaft surface must be smooth, without dimples, grooves or ridges, holes or roughness, and the finish shall be smooth and uniform throughout. The intent is that tape on the shaft shall not be legal except for the small labels for name or saying it conforms to IAAF rules. See the table in USATF Rule 193 for more details, and Rules 301 and 332.3(g) for the weight used by the various Youth and Master age groups.

The javelin consists of three parts - the shaft, the cord grip, and the head. The shaft must now be of metal construction and conform to a specific smooth profile, except in high school where it can still be made of solid wood. There are maximum and minimum length and diameter requirements for most of the parts. There are 17 such dimensions specified. The age-group for each weight javelin is shown in the following table:

	800 g	700g	600 g	500 g	400g
	Post 86		Post 99		
High School	Boys		Girls		
USA Youth		Boys	Girls		
USA Masters/ WMA	Men	Men & Women	Men & Women	Men & Women	Men & Women
NCAA	Men		Women		
USATF/ IAAF	Men		Women		

The javelin should not have any tape on it, which might help its flight characteristics; i.e., spiral wound. For more details, see Rule 193 in USATF or IAAF books, Rule 2-1 in the NCAA book, and Rule 6-6-1 and 2 in the High School book. See the high school book for details of rubber tips.

**YOUTH or MINI JAVELIN:**

In 2001, the USATF Youth Committee adopted the use of the Youth Javelin for their younger age groups. It is made in three weights - 300g, 400 g, and 500g, and other than the weight, the specifications are the same. Only the 300g javelin is currently thrown competitively. *Note: Currently the TurboJav™ is the only javelin that meets these specifications, although other manufactures may begin making them.*

The implement is much shorter and wider. The shaft, grip, and fins are made out of plastic, while the tip is made of soft rubber with a blunt, rounded tip. The fins must be smooth. For more details, see Rule 193.11.

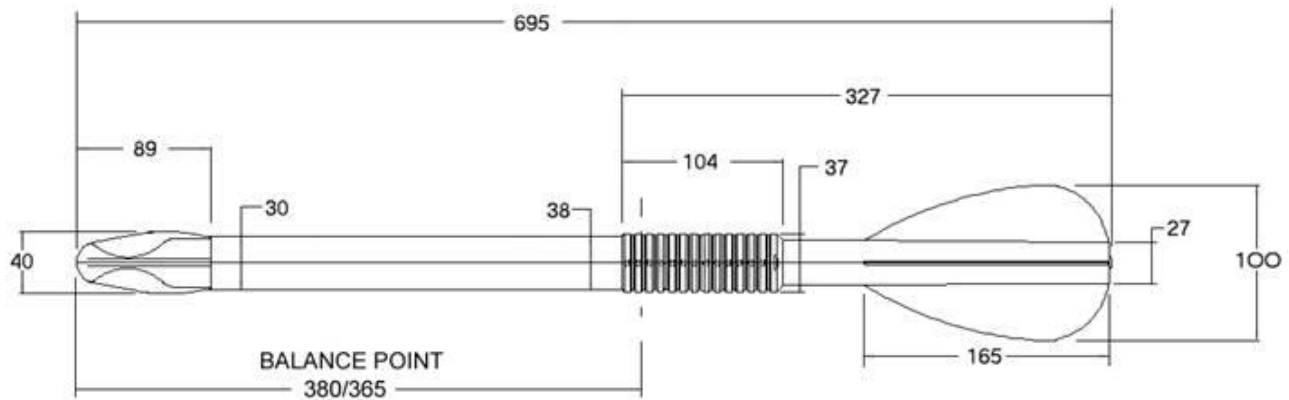

## APPENDIX B SECTOR AND VENUE LAYOUT

### SECTOR MEASUREMENT CHECK PROCEDURE

From the center of the circle or arc, measure out an equal distance on the inside of each sector line and mark those points. Mark each end point, and then measure between those points. The correct distance is shown in the table in the layout section for different distances from the center of the circle for each degree sector. For the javelin arc, you can get the center of the arc by swinging an eight meter arc from each corner of the foul arc back down the runway. Where they intersect is the center of the circle that makes up that arc. It should be back 8 meters and 2 meters in from either side of the runway.

### LAYOUT AND DIMENSIONS FOR A THROWING SECTOR

For historical reasons and because some sectors may not get changed I have left the dimensions for the five different sectors previously use - namely 28.95, 34.92, 40, 60, and 65.5 degrees. Each is laid out the same way. Starting in 2007 all sectors are once again the same for all but the Javelin.

Event	Currently	Before 2007 High School
Shot	34.92°	34.92°, 40° or 65.5°
Discus	34.92°	34.92°, 40° or 60°
Hammer/Weight	34.92°	N/A
Javelin	28.95°	28.95°

Formulae where 'a' is distance from center of circle or arc to point on inside of sector line, and 'b' is the distance from inside of one sector line to the point on the other sector, which is also 'a' units from the center of the arc or circle.

Sector	Event	Jurisdiction	Formula
28.95°	Javelin	All Currently	$b=0.5*a=a/2$
34.92°	All but Javelin	All Currently	$b=0.6*a$
40°	Most but Javelin	Old before 2004	$b=0.68404*a$
60°	Allowable	Old HS before 2007	$b=a$
65.5°*	Shot	Old HS before 2007	$b=1.14286*a$

**\*Note:** The 65.5 degrees sector is basically a sector line that is extended from the center of the circle at each edge of the toe board.

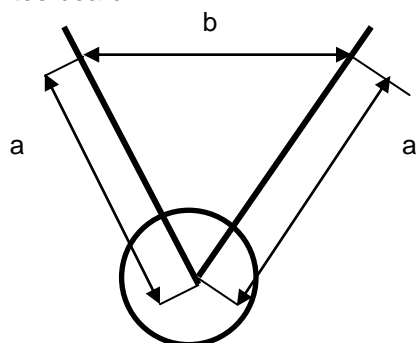

#### GENERAL SECTOR

a= DISTANCE OUT SECTOR LINES

b= DISTANCE BETWEEN SECTOR LINES



## Distance b for Various Sectors at Various Distances

A, meters	28.95 deg.	34.92 deg.	40 deg.	60 deg.	65.5 deg.
5.000	-	3.000	3.420	5.000	5.714
8.000	4.000	4.800	4.104	8.000	-
10.000	5.000	6.000	6.840	10.000	11.429
15.000	7.500	9.000	10.261	15.000	17.143
20.000	10.000	12.000	13.681	20.000	22.857
25.000	12.500	15.000	17.101	25.000	28.572
50.000	25.000	30.000	34.202	50.000	-
75.000	37.500	45.000	51.303	75.000	-
100.000	50.000	60.000	68.404	100.000	-

**Note:** The variability allowed in these measurements is the relative degree of accuracy expected. Although it is not in the rules, you should be within 0.1% or 1/1000 of the 'b' dimension. The further out the sector line you measure, the more accurate you will be and should be able to be within a centimeter or so. This translates into better than 1 in 5000 at 100 meters, and 1/1000 at 20 meters in the worst case.

### EXAMPLE OF LAYOUT PROCEDURE

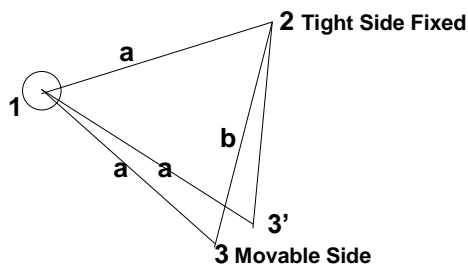

Line 1-2 = 100.000 m      Line 2-3 = 62.052m  
 Line 1-3 = 100.000 m      Line 2-3' = 60.000 m  
 Line 1-3' = 100.000 m

1. Layout the tightest sector line first (shown here as the left one). If neither is tight, then just lay out a line from the center of the circle, i.e. point 1 out 100 meters to point 2. Line 1-2. If you want to center the sector then use three tapes and move the center point of b to that point or go out along the center line 0.9539a. The sectors will be perpendicular to that line and 0.3a to either side.
2. Measure from the inside of the sector line over to the inside of the other sector line with tape and mark as point 3'. This distance should be 60.00m if 34.92 degree sector, 68.404m if 40 degrees sector, 100m if a 60 degree sector, and 50m if a javelin sector (28.95 degrees).
3. Run a line or a second tape from the center at point 1 to point 3', and then measure out 100m along that line and mark 3". If you have two tapes, you can get the point immediately by running one tape out from the center of the circle and one from point 2 at the appropriate length.
4. If 3' and 3" coincide, then you are through.
5. If not, then use tapes from 1 to 3 and 2 to 3 until they meet at the appropriate distance. Note - point 3 is always 100m from point 1 in all cases. This is point 3 and is the inside of the other sector line.

# Discus

January, 2006



N

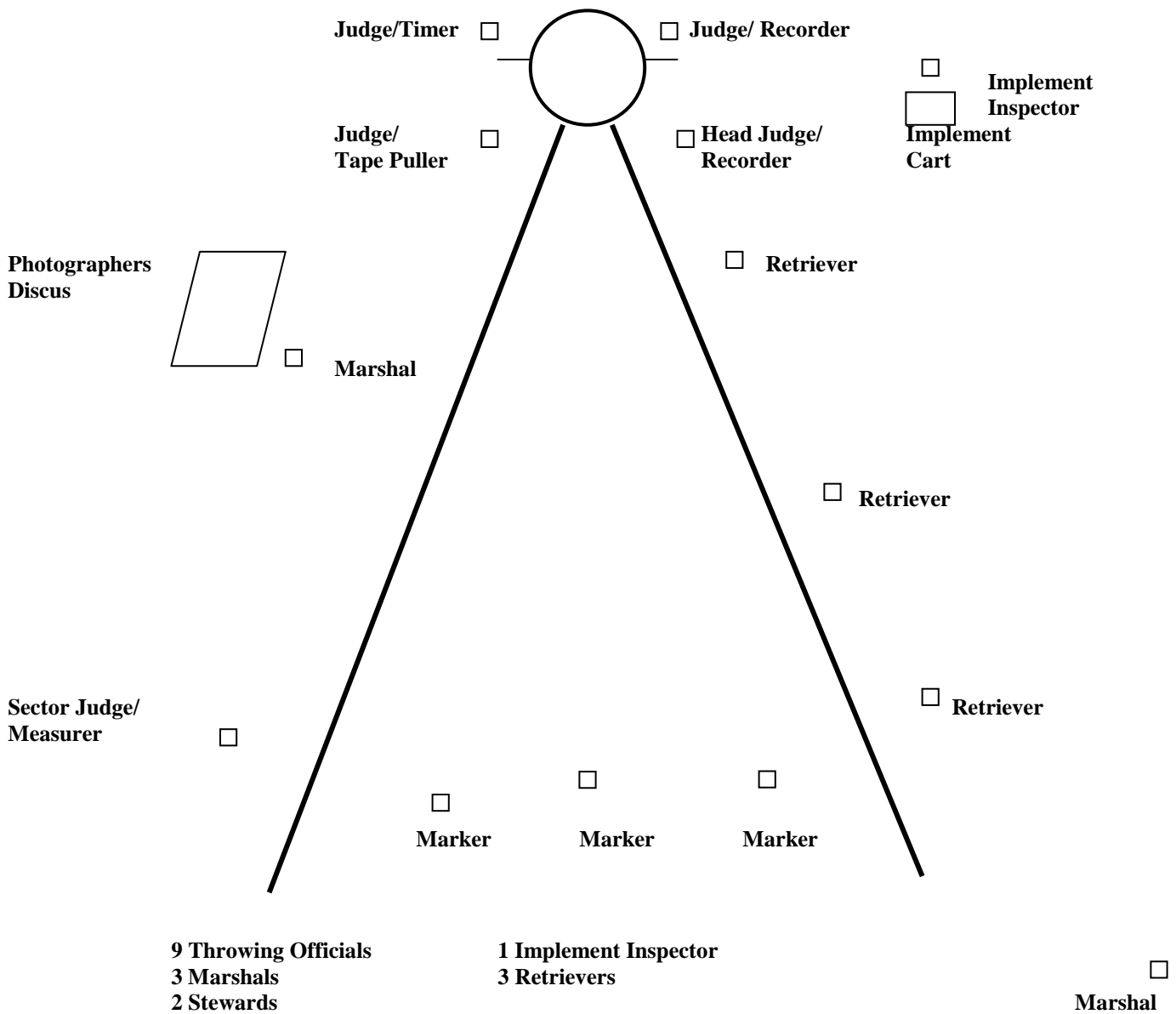
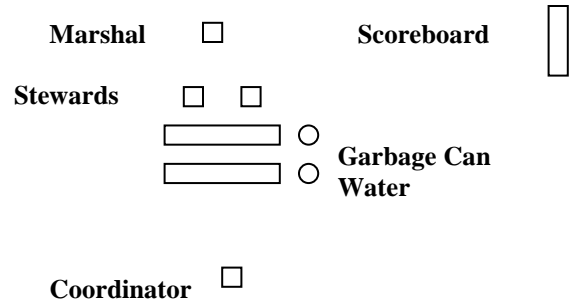

# Hammer

January, 2006

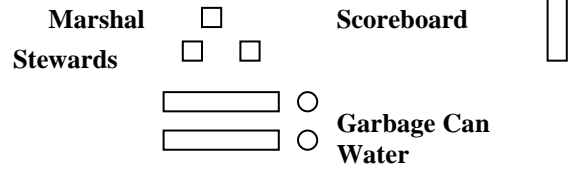

Coordinator □

Judge/Timer □

□ Judge/ Recorder

Judge/Gate/  
Tape Puller □

□ Head Judge  
Gate/Recorder

Implement  
Inspector  
Implement  
Cart

□ Retriever

□ Retriever

□ Retriever

Sector Judge /  
Measurer □

Marker □

Marker □

Marker □

Photographers

Sector Marshal  
for Hammer □

9 Throwing Officials  
3 Marshals  
2 Stewards

1 Implement Inspector  
3 Retrievers

Marshal □



# Shot

January, 2006

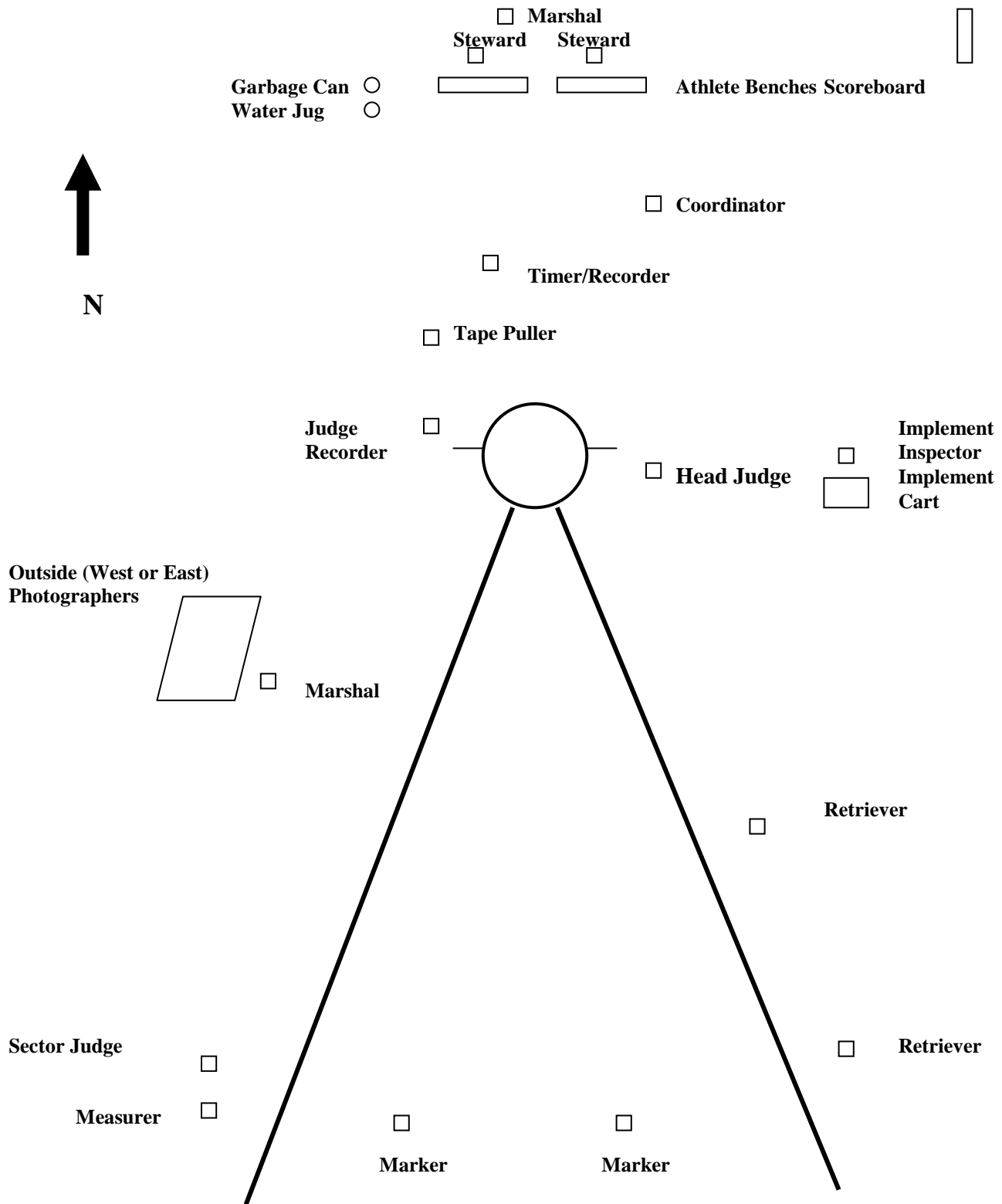

- 9 Throwing Officials
- 2 Marshals
- 2 Stewards
- 1 Implement Inspector
- 2 Retrievers